







Model name	Model cycle	Site
 Audi 80		
Audi 80 / S2	1990 – 1995	3
Audi 80 / S2 / RS2 Avant	1992 – 1995	4
Audi 80 / S2 Coupé	1988 – 1996	5
Audi 80 Cabriolet	1991 – 2000	6
 Audi 100		
Audi 100	1988 – 1991	7
Audi 100 Avant	1988 – 1991	8
Audi 100 / A6 / S6	1991 – 1997	9
Audi 100 / A6 / S6 Avant	1991 – 1997	10
 Audi 200		
Audi 200 / V8	1984 – 1991	11
Audi 200 Avant	1985 – 1991	12
 Audi A2		
Audi A2	2000 – 2005	13
 Audi A3		
Audi A3 (5-door)	1999–2003	14
Audi A3 / S3 (3-door)	1996–2003	15
Audi A3 / S3 (3-door)	2003–2012	16
Audi A3 / S3 / RS3 Sportback	2004 - 2013	17
 Audi A4		
Audi A4 / S4	1995–2001	18
Audi A4 / S4 / RS4 Avant	1996–2001	19
Audi A4 / S4	2001–2005	20
Audi A4 / S4 Avant	2001–2005	21
Audi A4 / S4 Cabriolet	2002–2005	22
Audi A4 / S4 / RS4	2005–2007	23
Audi A4 / S4 / RS4 Avant	2005–2008	24
Audi A4 / S4 / RS4 Cabriolet	2005–2009	25



Audi A6

Audi A6 / S6 / RS6	1997–2004	26
Audi A6 / S6 / RS6 Avant	1998 –2004	27
Audi A6 allroad	2001–2006	28
Audi A6 / S6 / RS6	2004–2008	29
Audi A6 / S6 / RS6 Avant	2004 –2012	30



Audi A8

Audi A8 / S8	1994–2002	31
Audi A8 / S8	2002–2010	32



Audi TT

Audi TT Coupé	1998–2006	33
Audi TT Roadster	1999–2006	34

Legal Disclaimer:

This manual has been created exclusively for rescuers who have been specially trained in the area of providing emergency rescue after automobile accidents and who are therefore qualified to use the activities described in this manual. Furthermore, this manual shows the maximum possible equipment specification in the model overview.

Vehicle specifications and special options as well as Audi model availability are constantly subject to change. Therefore, Audi reserves the right to change the content of this manual at all times.

Please note: The information contained in this manual is not intended for customers or for repair shops and dealers. Customers may gather detailed information from their vehicle owner’s manual regarding vehicle function as well as any occupant safety features and system descriptions.

Repair shops and dealers obtain repair information through their normal channels.

(Status: 09/2019)



Hint:

The maximum possible equipment specification is always shown in the model overview.

You will find “Rescue and Recovery involving Audi Vehicles” in a separate part of the same title.

The creation of this Rescue Data sheets is supported by Moditech Rescue Solutions (www.moditech.com). The vehicle overviews in the attachment are also included in interactive form in the data base “Crash Recovery System”.

This document is a subject to the copyright of AUDI AG, Ingolstadt. Any duplication, distribution, storage, communication, broadcast and reproduction or transmission of the contents without written approval from AUDI AG is prohibited.



▶ Audi 80 / S2

1990 – 1995

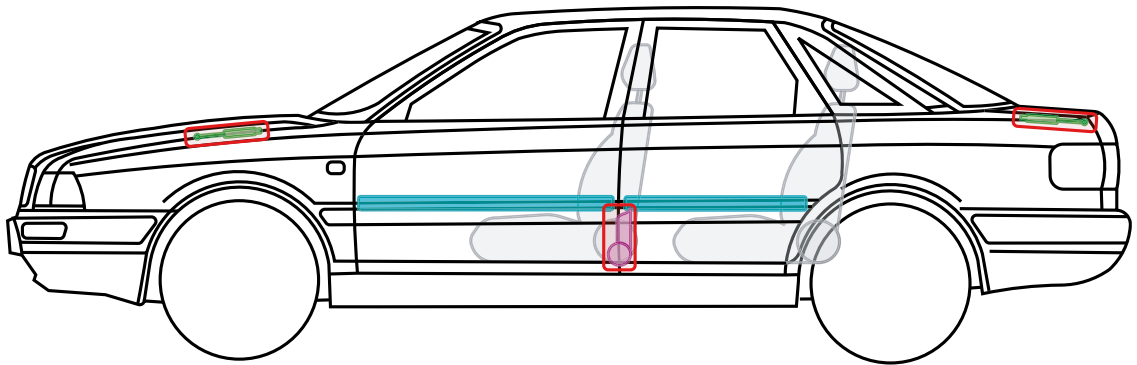
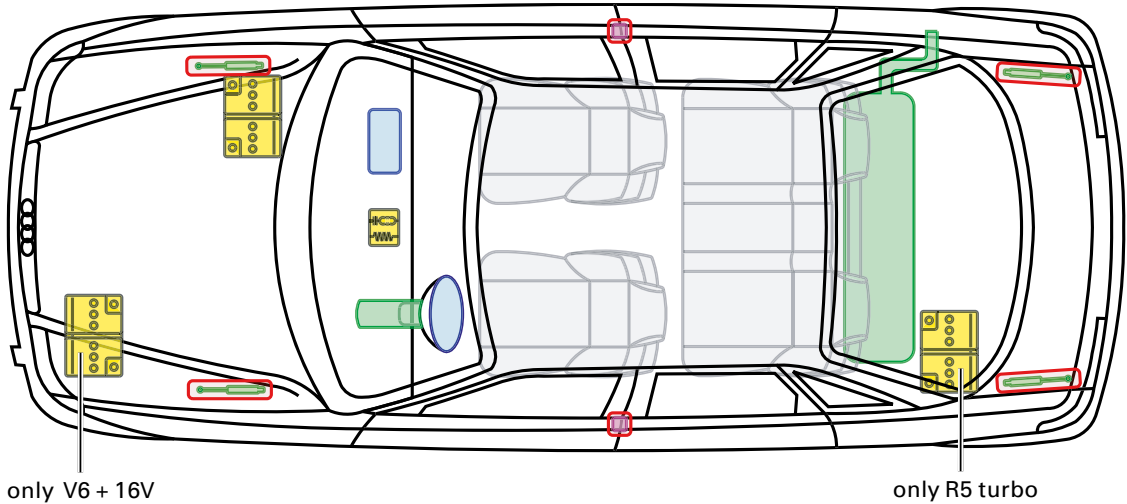

Legend

	Airbag		Reinforcement		Control module
	Gas generator		Rollover protection		Battery
	Pre-tensioner		Gas-pressure damper		Fuel tank

This document is a subject to the copyright of AUDI AG, Ingolstadt. Any duplication, distribution, storage, communication, broadcast and reproduction or transmission of the contents without written approval from AUDI AG is prohibited.



▶ Audi 80 / S2 / RS2 Avant

1992 – 1995

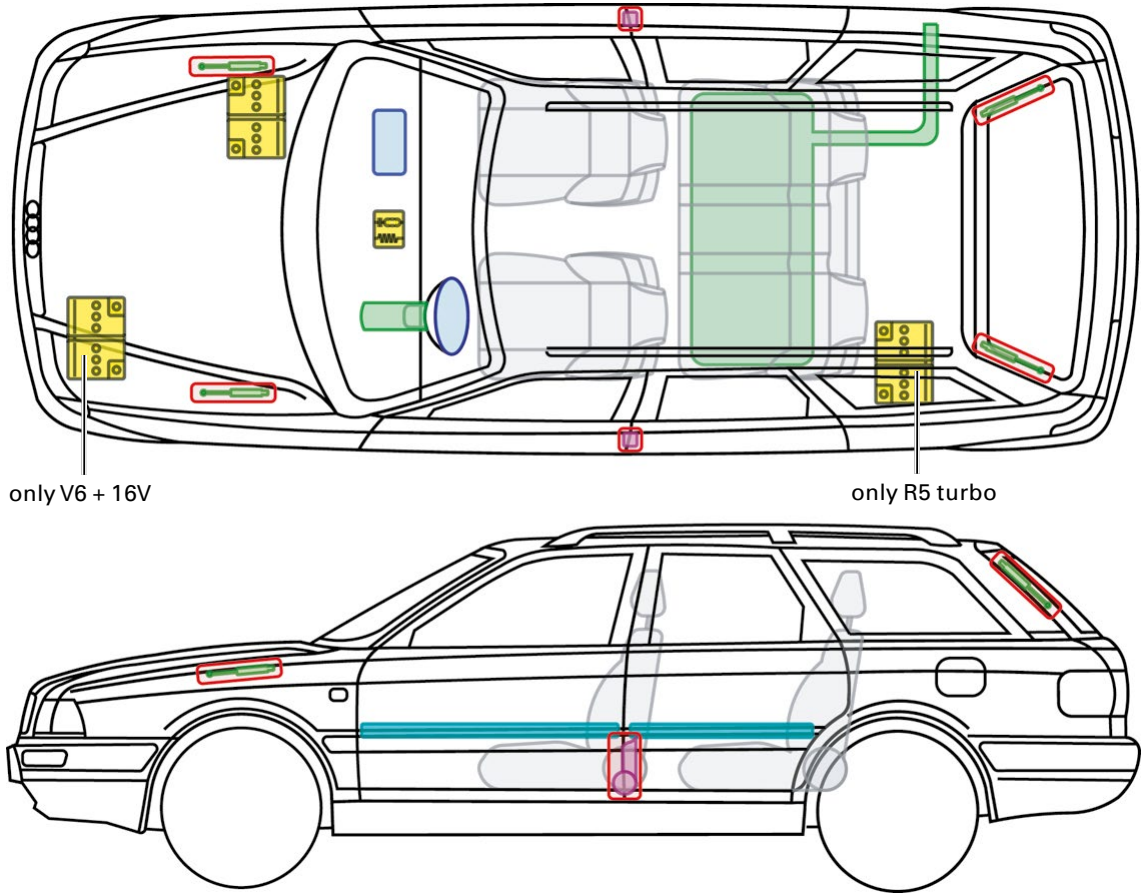

only V6 + 16V

only R5 turbo

Legend

	Airbag		Reinforcement		Control module
	Gas generator		Rollover protection		Battery
	Pre-tensioner		Gas-pressure damper		Fuel tank

This document is a subject to the copyright of AUDI AG, Ingolstadt. Any duplication, distribution, storage, communication, broadcast and reproduction or transmission of the contents without written approval from AUDI AG is prohibited.







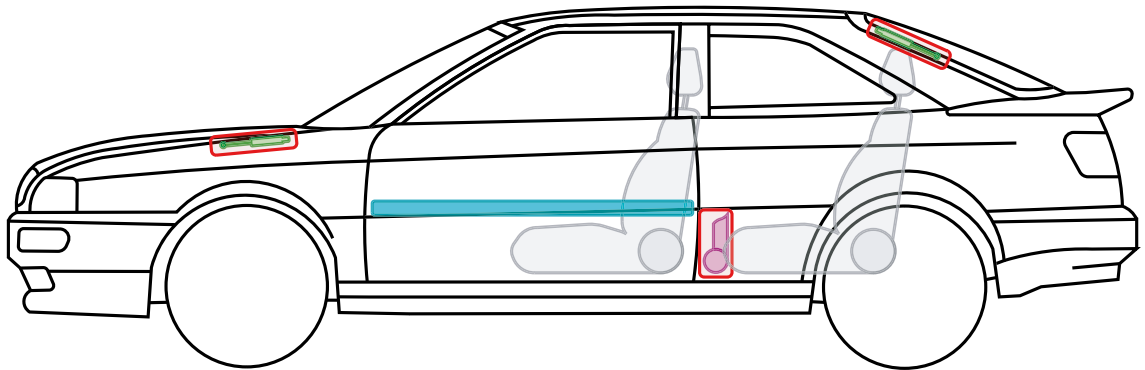
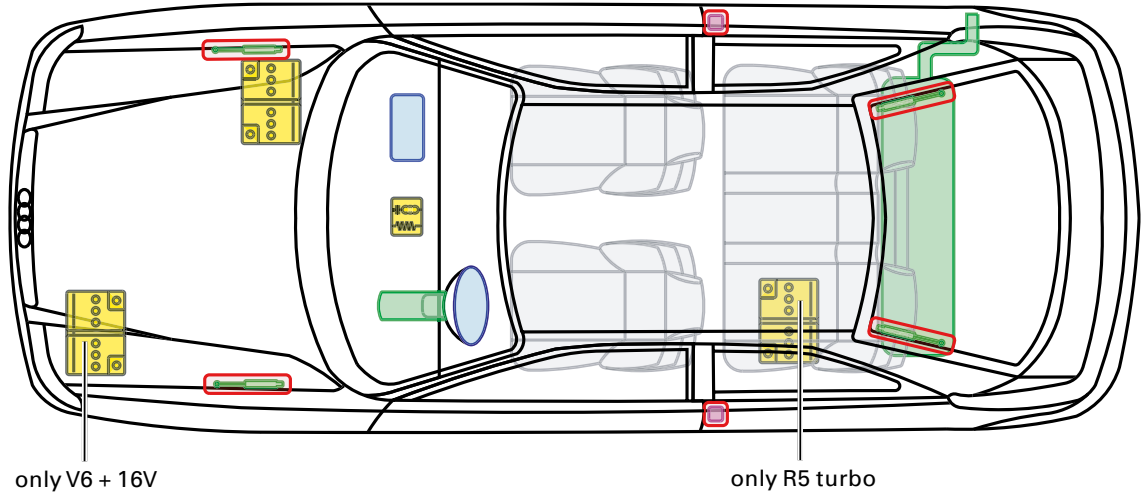

▶ Audi 80 / S2 Coupé

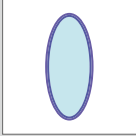
1988 – 1996

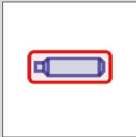

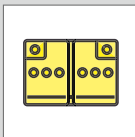
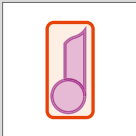
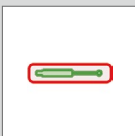
Legend

	Airbag		Reinforcement		Control module
	Gas generator		Rollover protection		Battery
	Pre-tensioner		Gas-pressure damper		Fuel tank

This document is a subject to the copyright of AUDI AG, Ingolstadt. Any duplication, distribution, storage, communication, broadcast and reproduction or transmission of the contents without written approval from AUDI AG is prohibited.







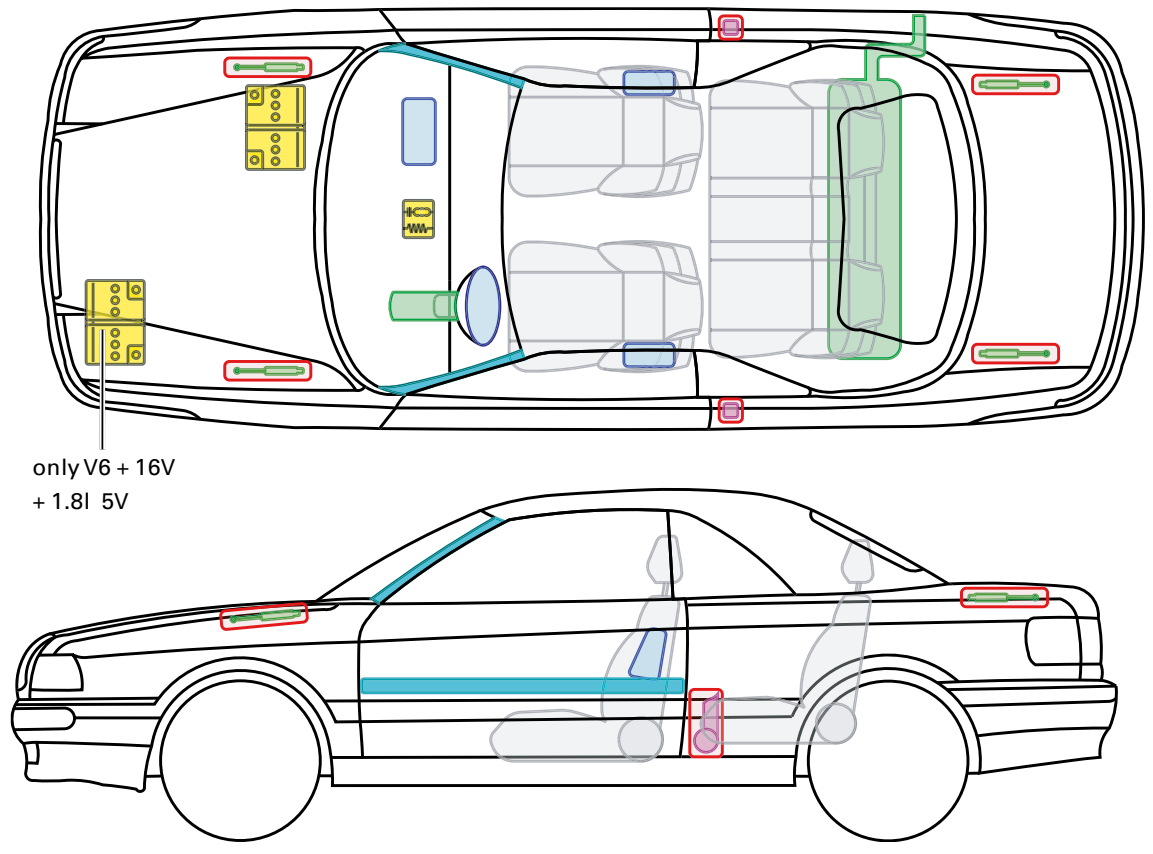

▶ Audi 80 Cabriolet

1991 – 2000

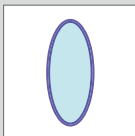
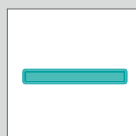

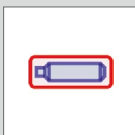
only V6 + 16V
+ 1.8l 5V

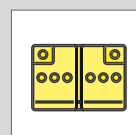
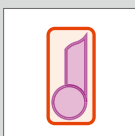
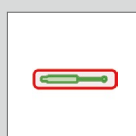
Legend

	Airbag		Reinforcement		Control module
	Gas generator		Rollover protection		Battery
	Pre-tensioner		Gas-pressure damper		Fuel tank

This document is a subject to the copyright of AUDI AG, Ingolstadt. Any duplication, distribution, storage, communication, broadcast and reproduction or transmission of the contents without written approval from AUDI AG is prohibited.



▶ Audi 100

1988 – 1991

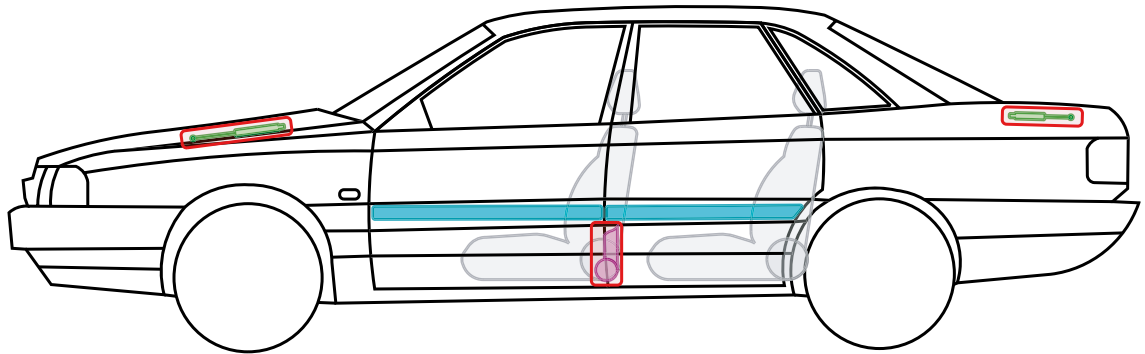
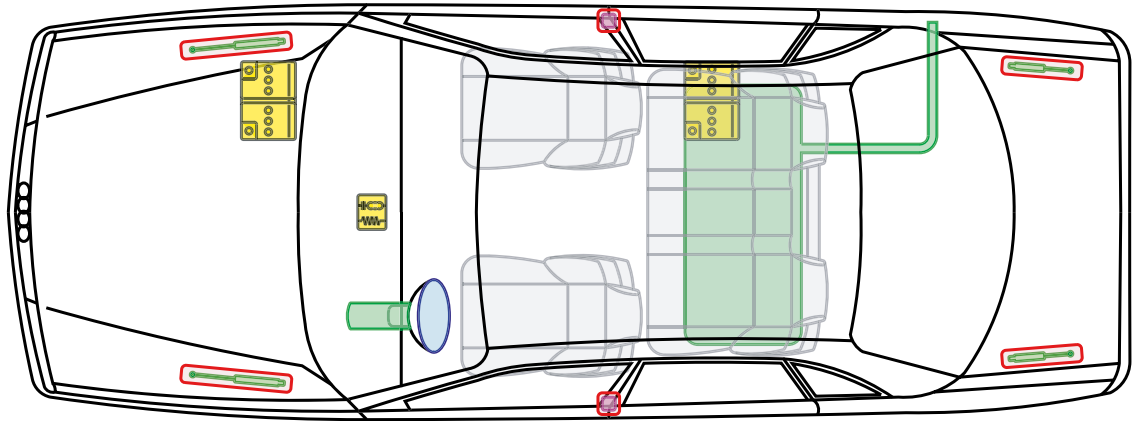

Legend

	Airbag		Reinforcement		Control module
	Gas generator		Rollover protection		Battery
	Pretensioner		Gas-pressure damper		Fuel tank

This document is a subject to the copyright of AUDI AG, Ingolstadt. Any duplication, distribution, storage, communication, broadcast and reproduction or transmission of the contents without written approval from AUDI AG is prohibited.



▶ Audi 100 Avant

1988 – 1991

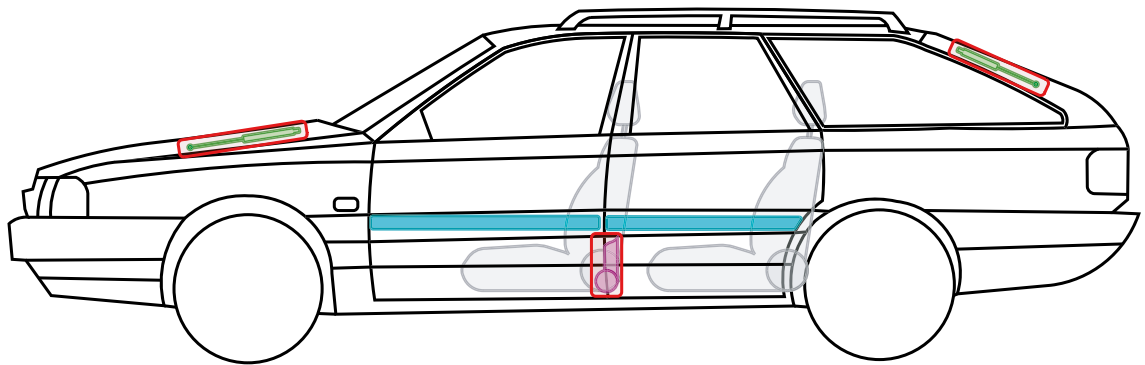
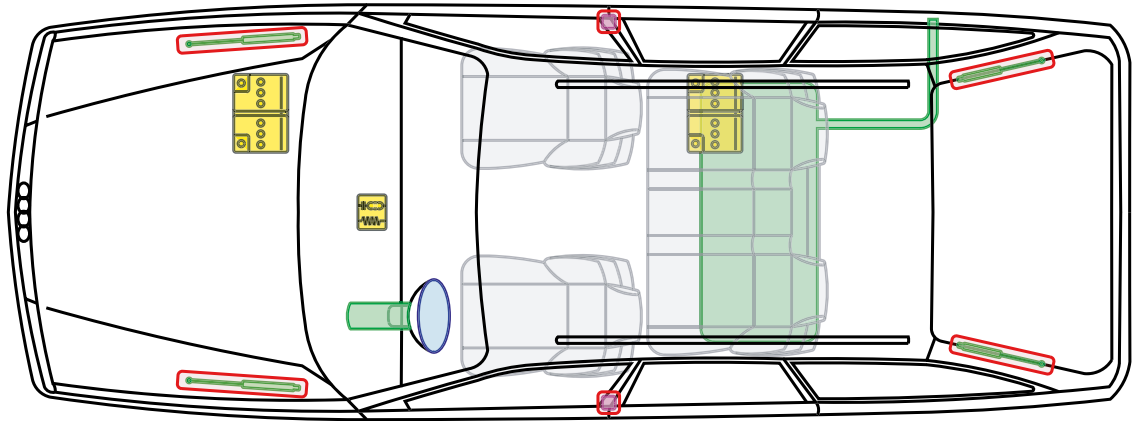

Legend

	Airbag		Reinforcement		Control module
	Gas generator		Roll-over protection		Battery
	Pretensioner		Gas-pressure damper		Fuel tank

This document is a subject to the copyright of AUDI AG, Ingolstadt. Any duplication, distribution, storage, communication, broadcast and reproduction or transmission of the contents without written approval from AUDI AG is prohibited.



▶ Audi 100 / A6 / S6

1991 – 1997

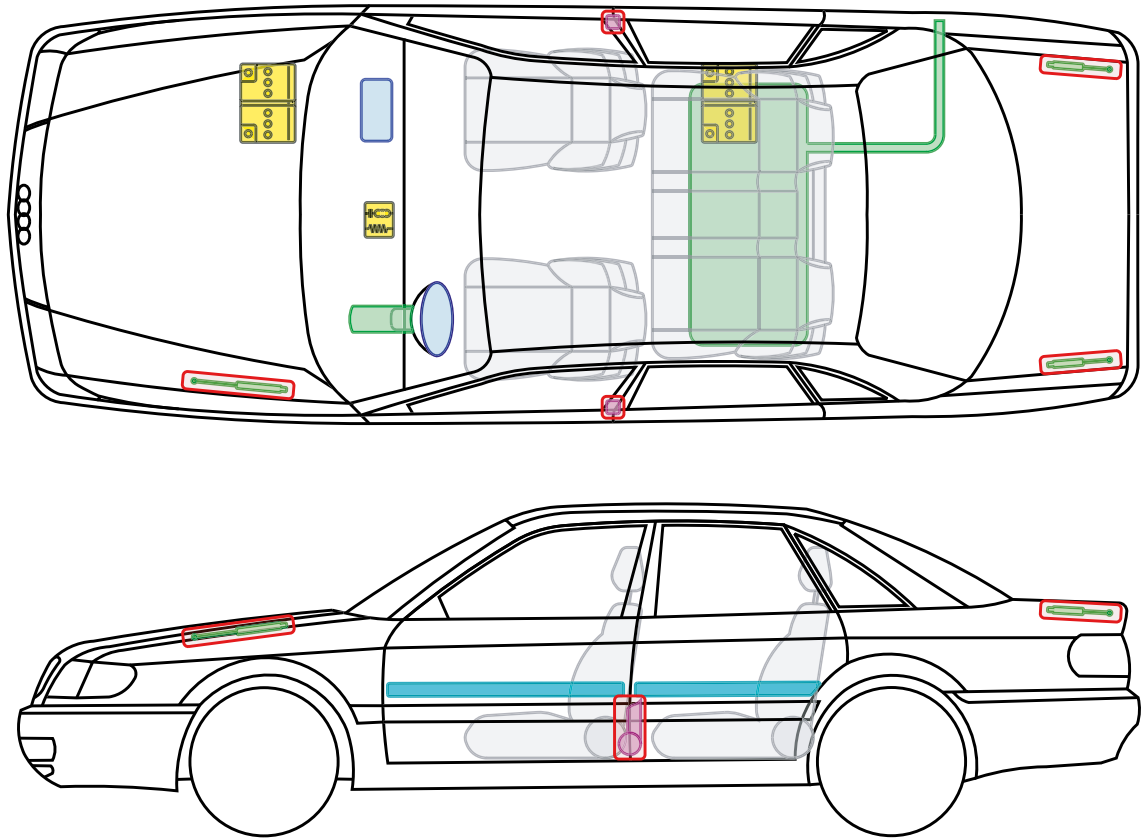

Legend

	Airbag		Reinforcement		Control module
	Gas generator		Rollover protection		Battery
	Pretensioner		Gas-pressure damper		Fuel tank

This document is a subject to the copyright of AUDI AG, Ingolstadt. Any duplication, distribution, storage, communication, broadcast and reproduction or transmission of the contents without written approval from AUDI AG is prohibited.







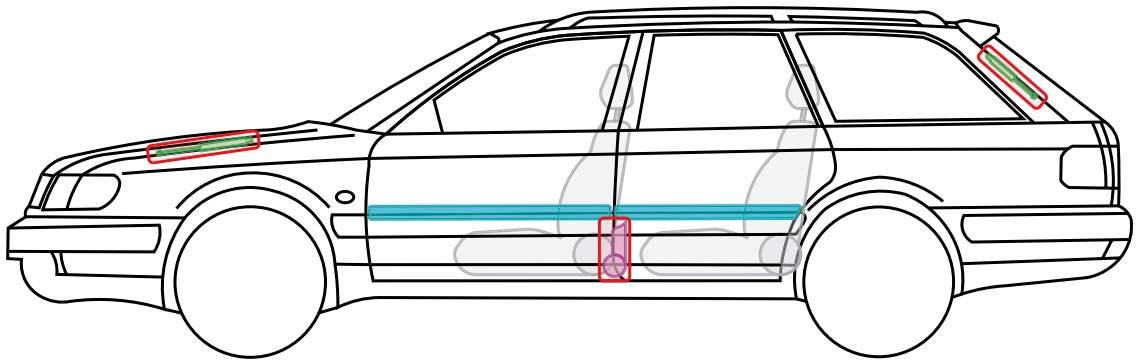
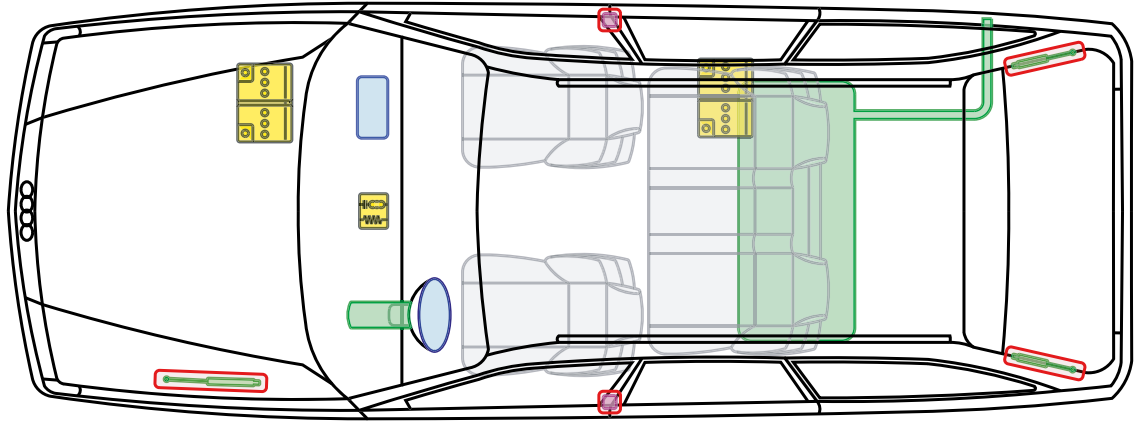

▶ Audi 100 / A6 / S6 Avant

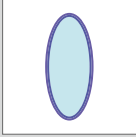
1991 – 1997

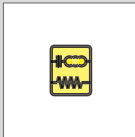
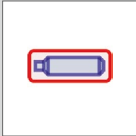

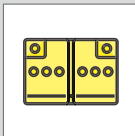
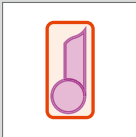
Legend

	Airbag		Reinforcement		Control module
	Gas generator		Rollover protection		Battery
	Pre-tensioner		Gas-pressure damper		Fuel tank

This document is a subject to the copyright of AUDI AG, Ingolstadt. Any duplication, distribution, storage, communication, broadcast and reproduction or transmission of the contents without written approval from AUDI AG is prohibited.



▶ Audi 200 / V8

1984 – 1991

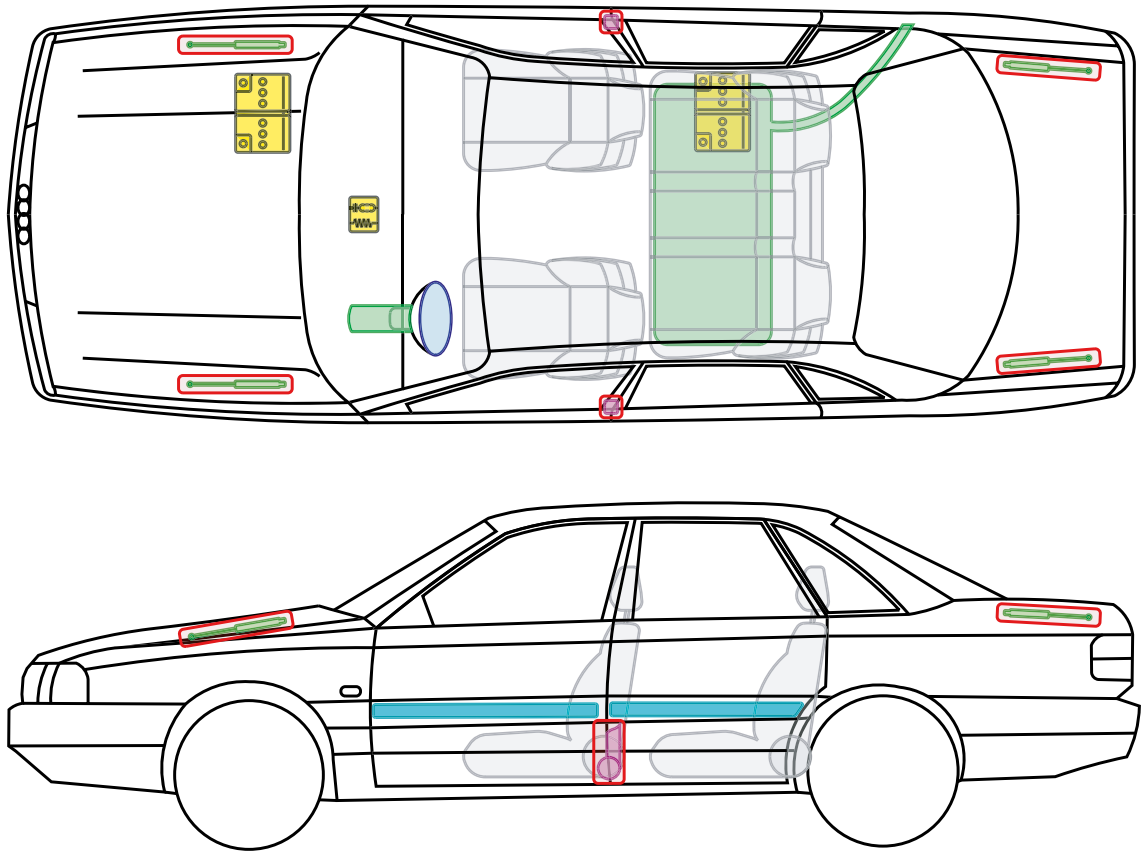

Legend

	Airbag		Reinforcement		Control module
	Gas generator		Rollover protection		Battery
	Pretensioner		Gas-pressure damper		Fuel tank

This document is a subject to the copyright of AUDI AG, Ingolstadt. Any duplication, distribution, storage, communication, broadcast and reproduction or transmission of the contents without written approval from AUDI AG is prohibited.



▶ Audi 200 Avant

1985 – 1991

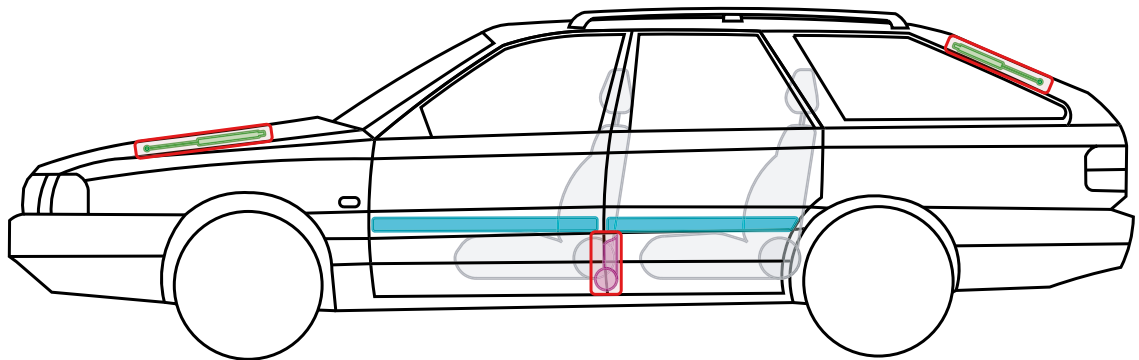
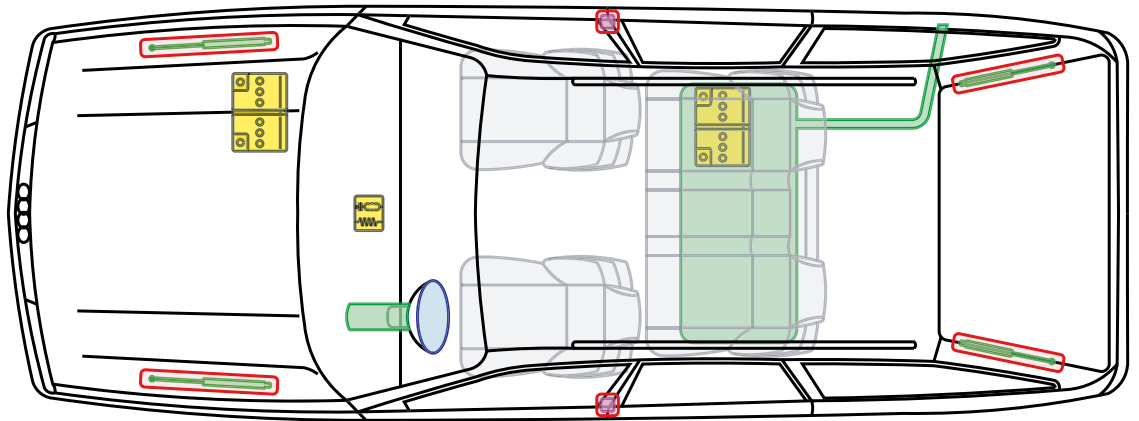

Legend

	Airbag		Reinforcement		Control module
	Gas generator		Roll-over protection		Battery
	Pretensioner		Gas-pressure damper		Fuel tank

This document is a subject to the copyright of AUDI AG, Ingolstadt. Any duplication, distribution, storage, communication, broadcast and reproduction or transmission of the contents without written approval from AUDI AG is prohibited.







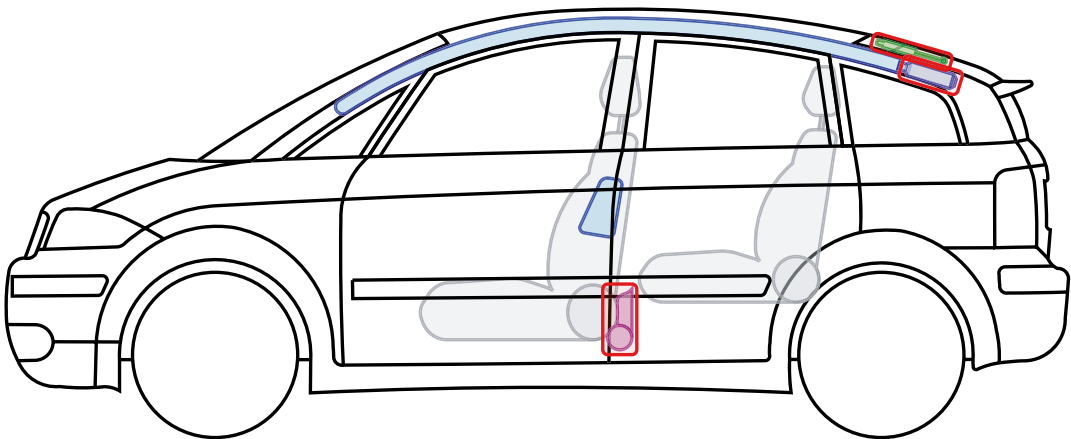
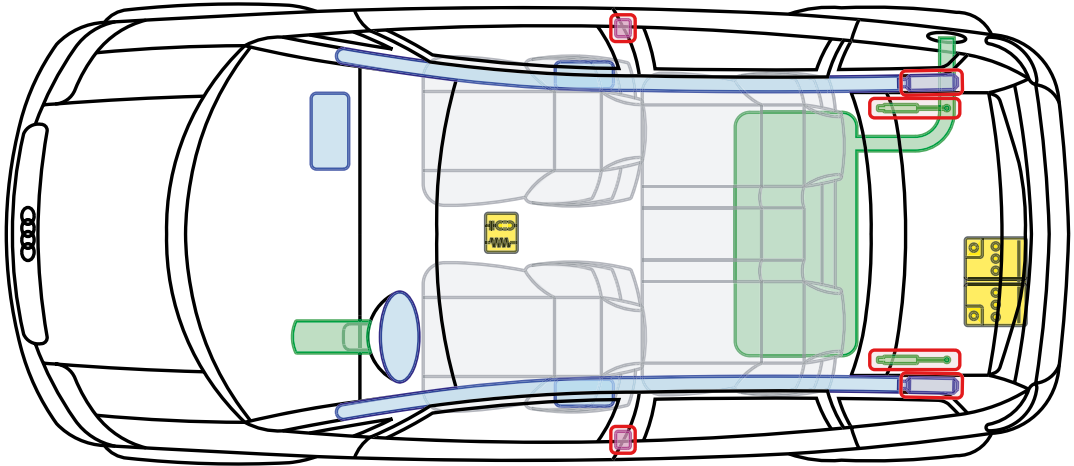

▶ Audi A2

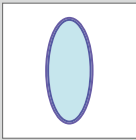
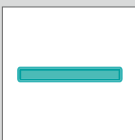
2000 – 2005

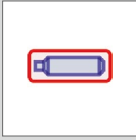

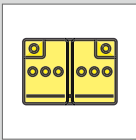
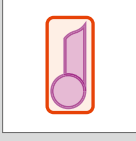
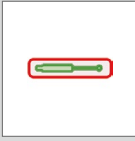
Legend

	Airbag		Reinforcement		Control module
	Gas generator		Rollover protection		Battery
	Pre-tensioner		Gas-pressure damper		Fuel tank







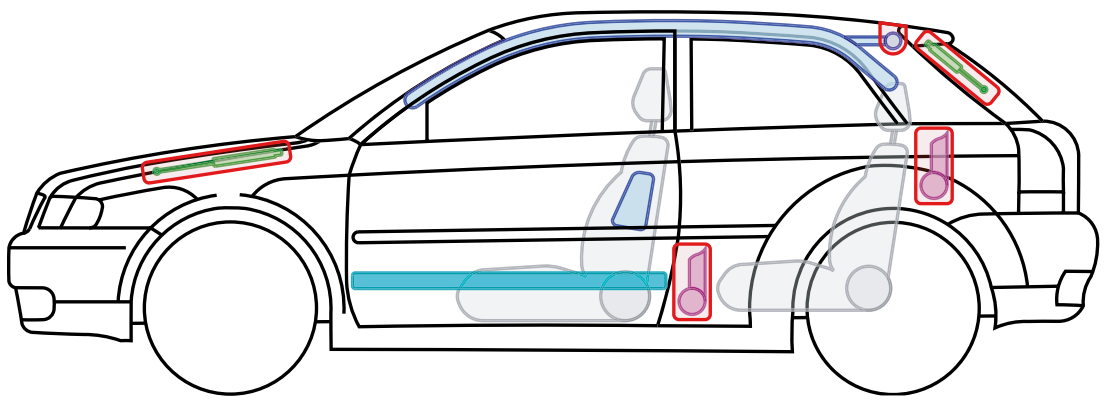
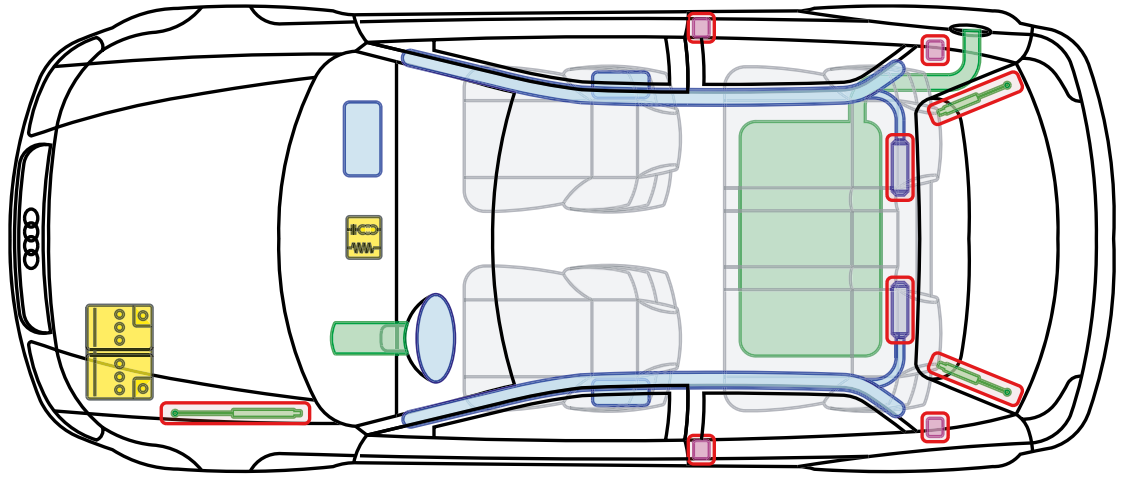

▶ Audi A3 / S3 (3-door)

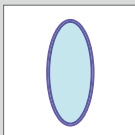
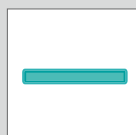
1996 – 2003

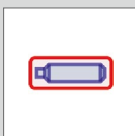

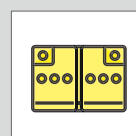
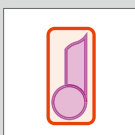
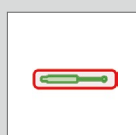
Legend

	Airbag		Reinforcement		Control module
	Gas generator		Rollover protection		Battery
	Pre-tensioner		Gas-pressure damper		Fuel tank

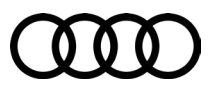







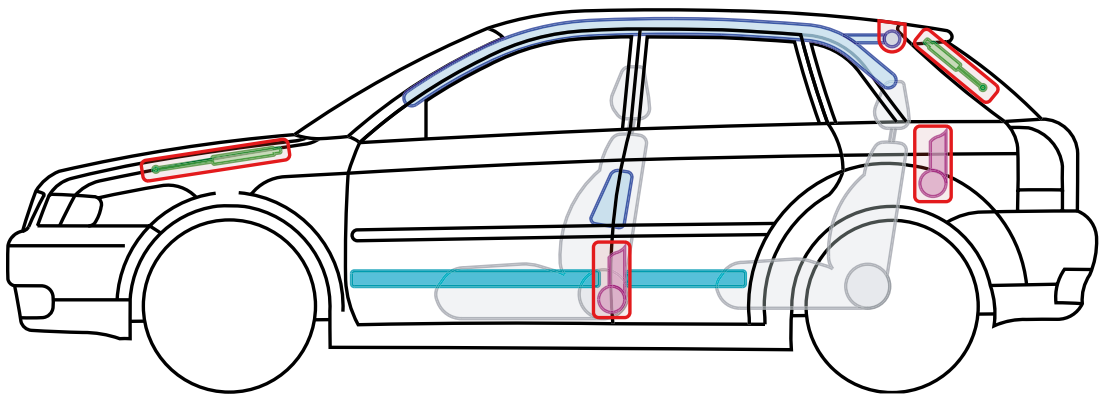
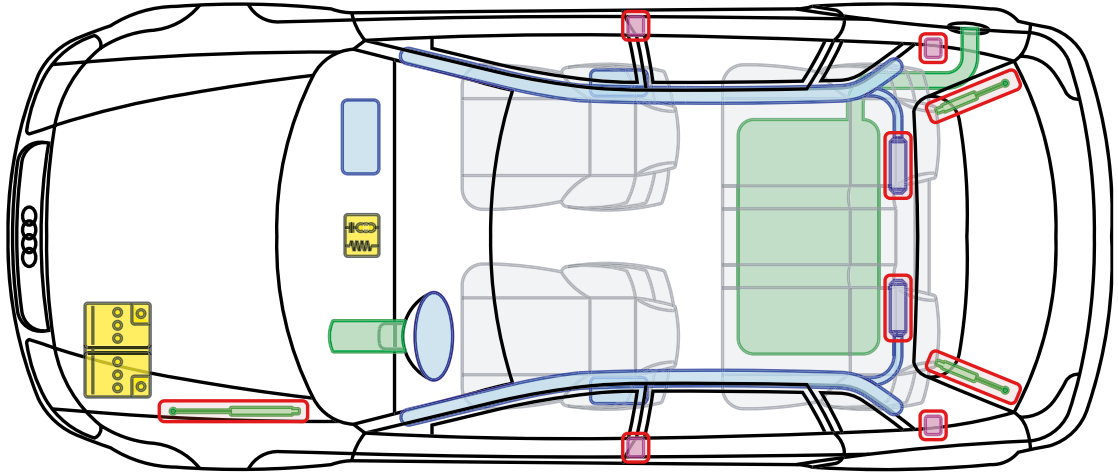

▶ Audi A3 (5-door)

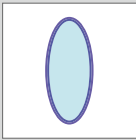
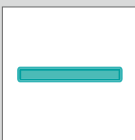
1999 – 2003

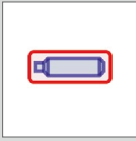

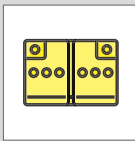
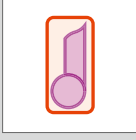
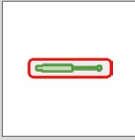
Legend

	Airbag		Reinforcement		Control module
	Gas generator		Rollover protection		Battery
	Pretensioner		Gas-pressure damper		Fuel tank







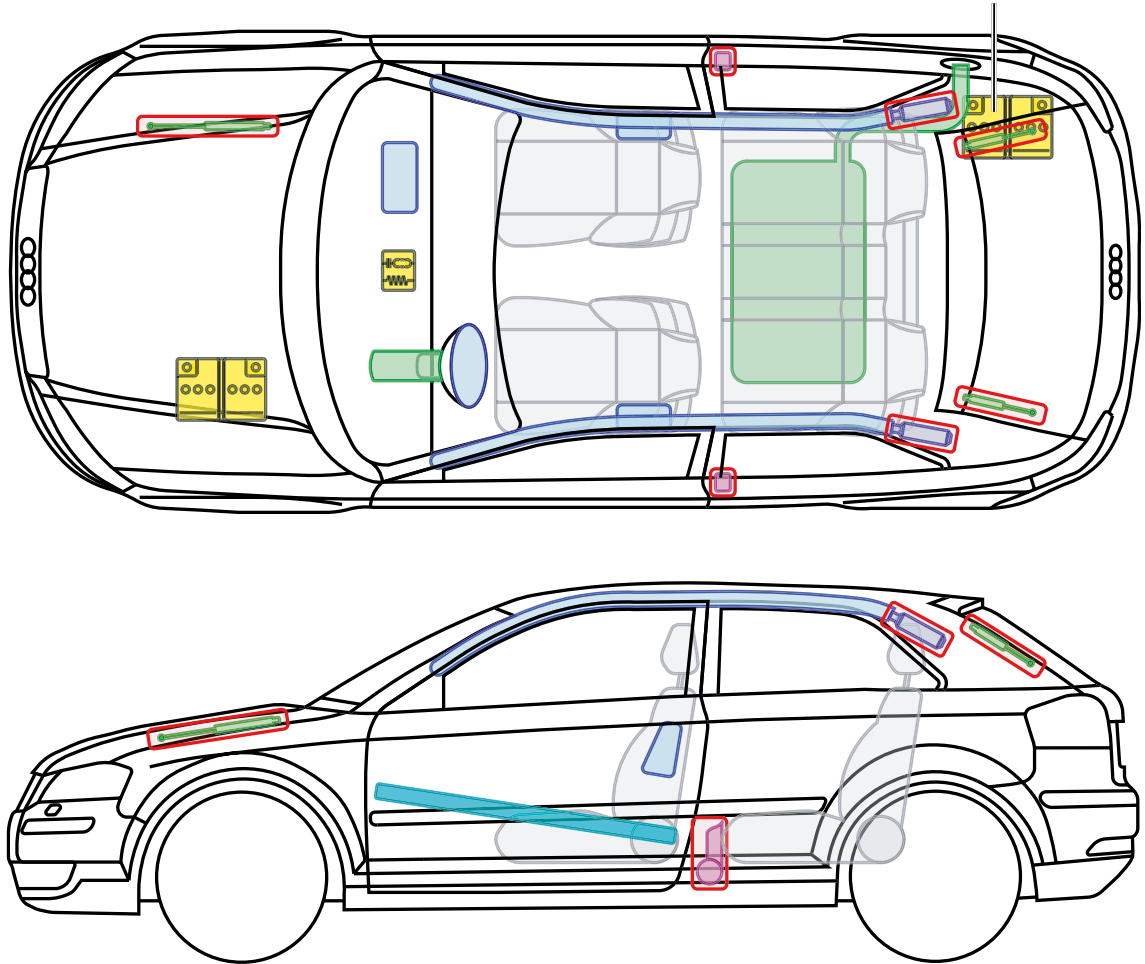

▶ Audi A3 / S3 (3-door)

2003 – 2012

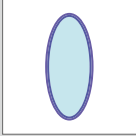
only V6 quattro

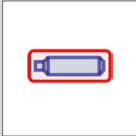

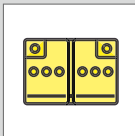
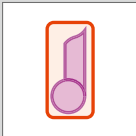
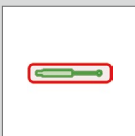
Legend

	Airbag		Reinforcement		Control module
	Gas generator		Rollover protection		Battery
	Pre-tensioner		Gas-pressure damper		Fuel tank









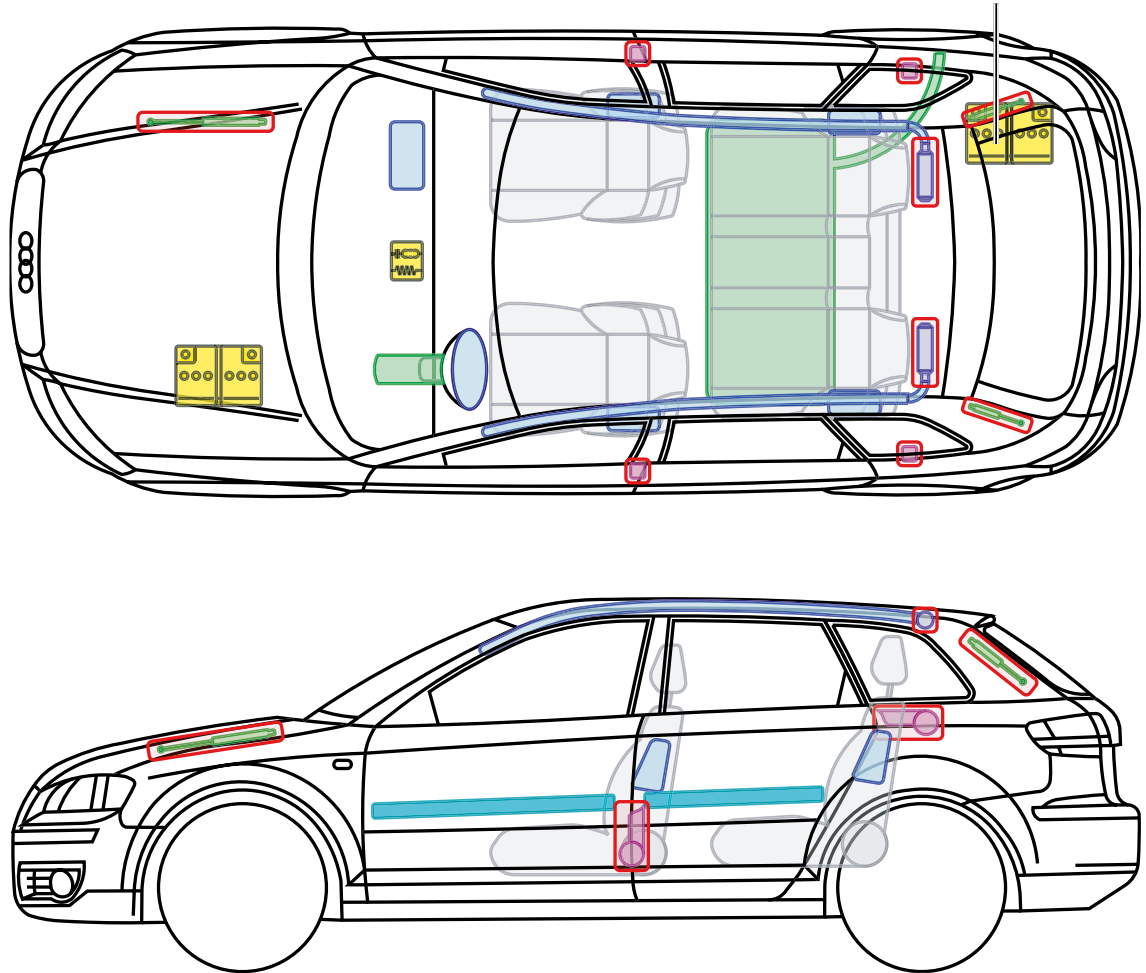

▶ Audi A3 / S3 / RS3 Sportback

2004 – 2013

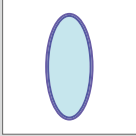
only V6 quattro + RS3

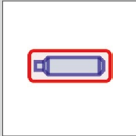

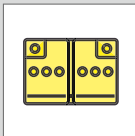
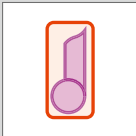
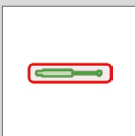
Legend

	Airbag		Reinforcement		Control module
	Gas generator		Rollover protection		Battery
	Pretensioner		Gas-pressure damper		Fuel tank





▶ Audi A4 / S4

1995 – 2001

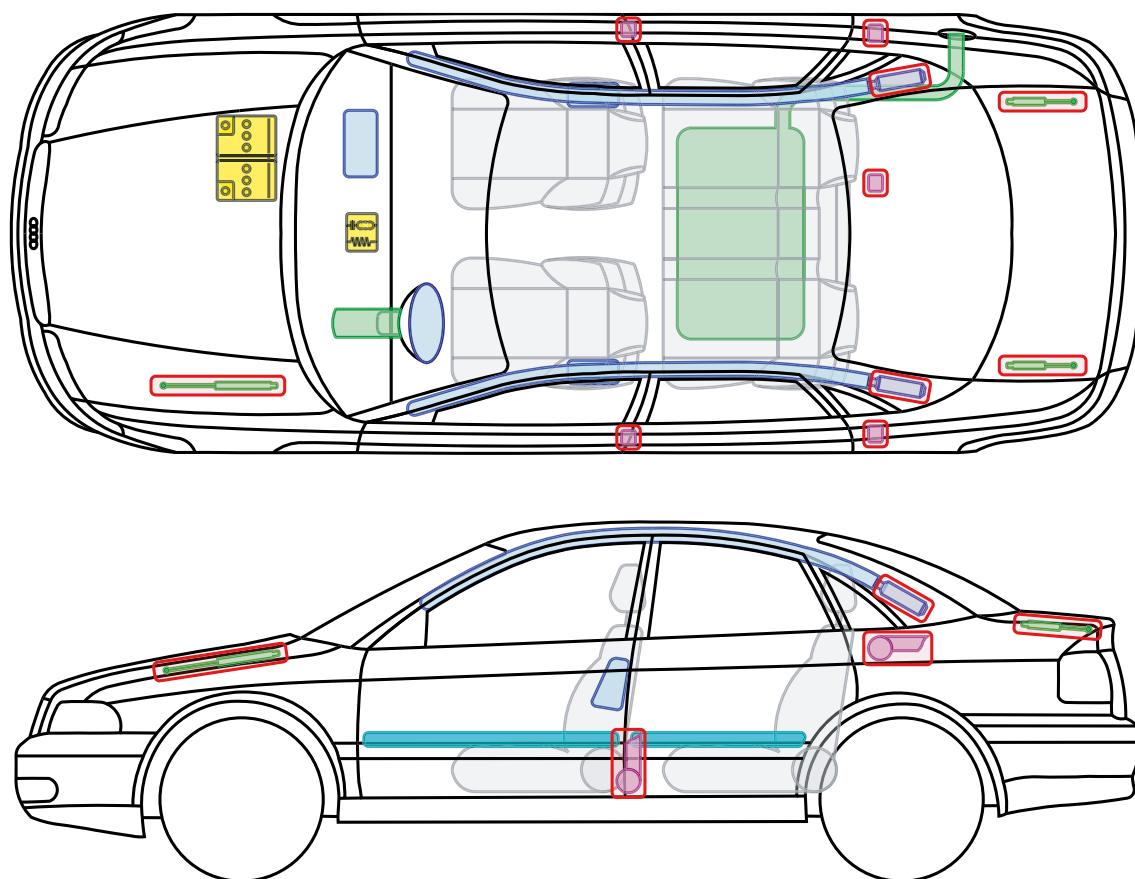

Legend

	Airbag		Reinforcement		Control module
	Gas generator		Rollover protection		Battery
	Pretensioner		Gas-pressure damper		Fuel tank

A4 + S4 Limousine



▶ Audi A4 / S4 / RS4 Avant

1996 – 2001

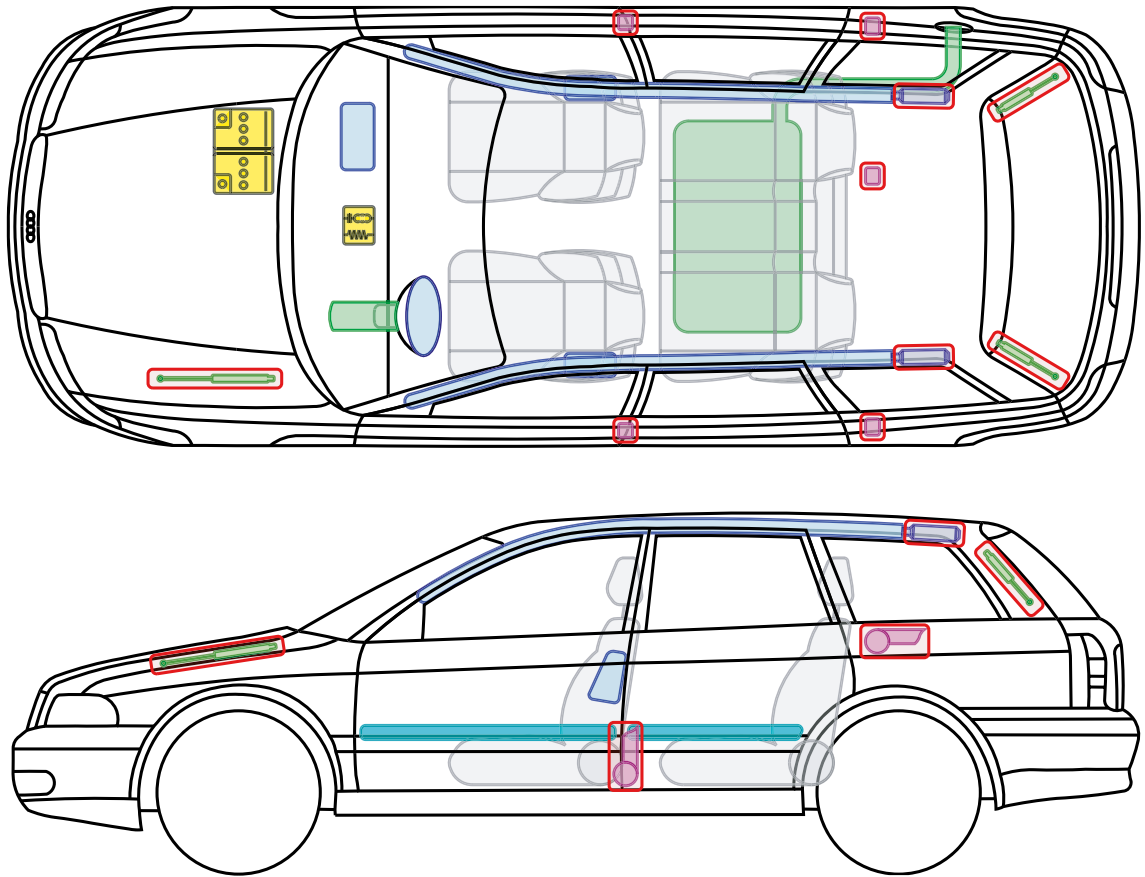

Legend

	Airbag		Reinforcement		Control module
	Gas generator		Rollover protection		Battery
	Pre-tensioner		Gas-pressure damper		Fuel tank







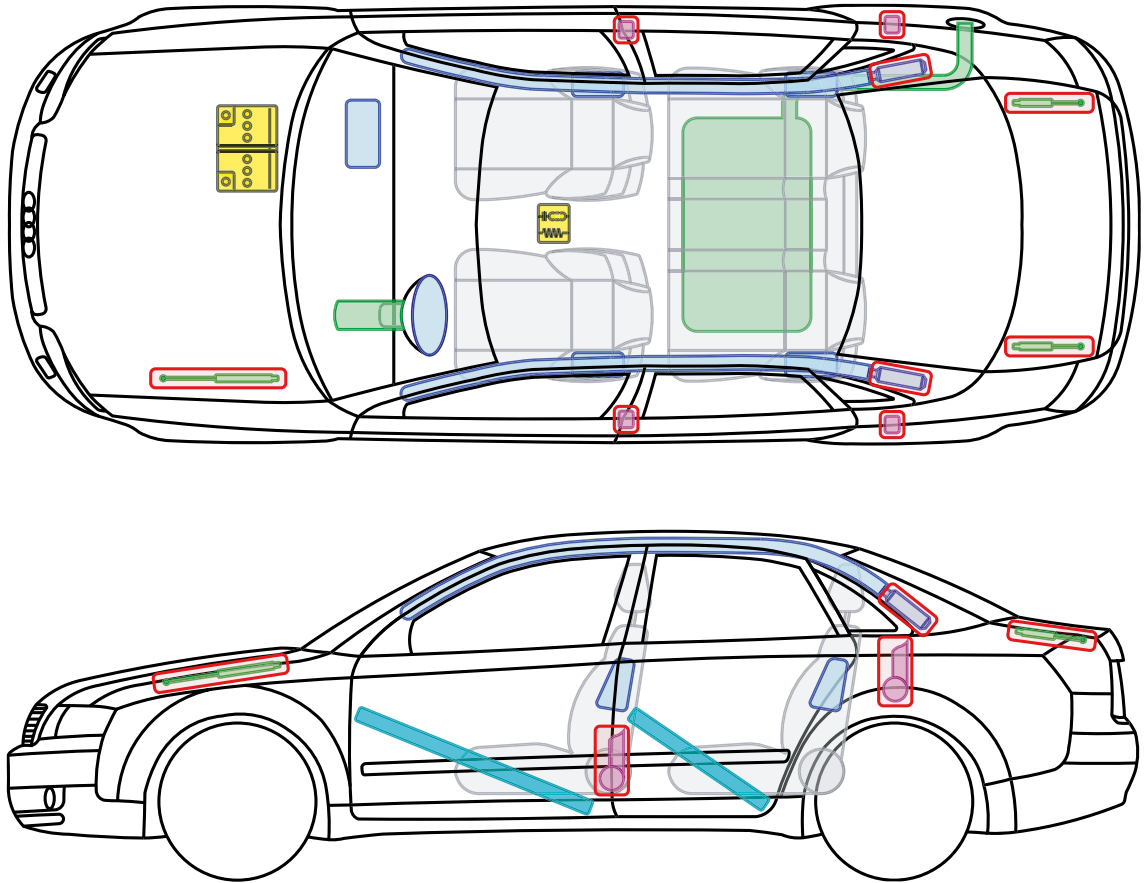

▶ Audi A4 / S4

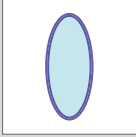
2001 – 2005

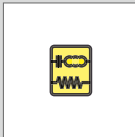
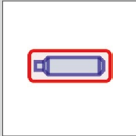

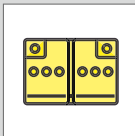
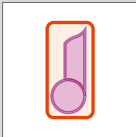
Legend

	Airbag		Reinforcement		Control module
	Gas generator		Rollover protection		Battery
	Pre-tensioner		Gas-pressure damper		Fuel tank



▶ Audi A4 / S4 Avant

2001 – 2005

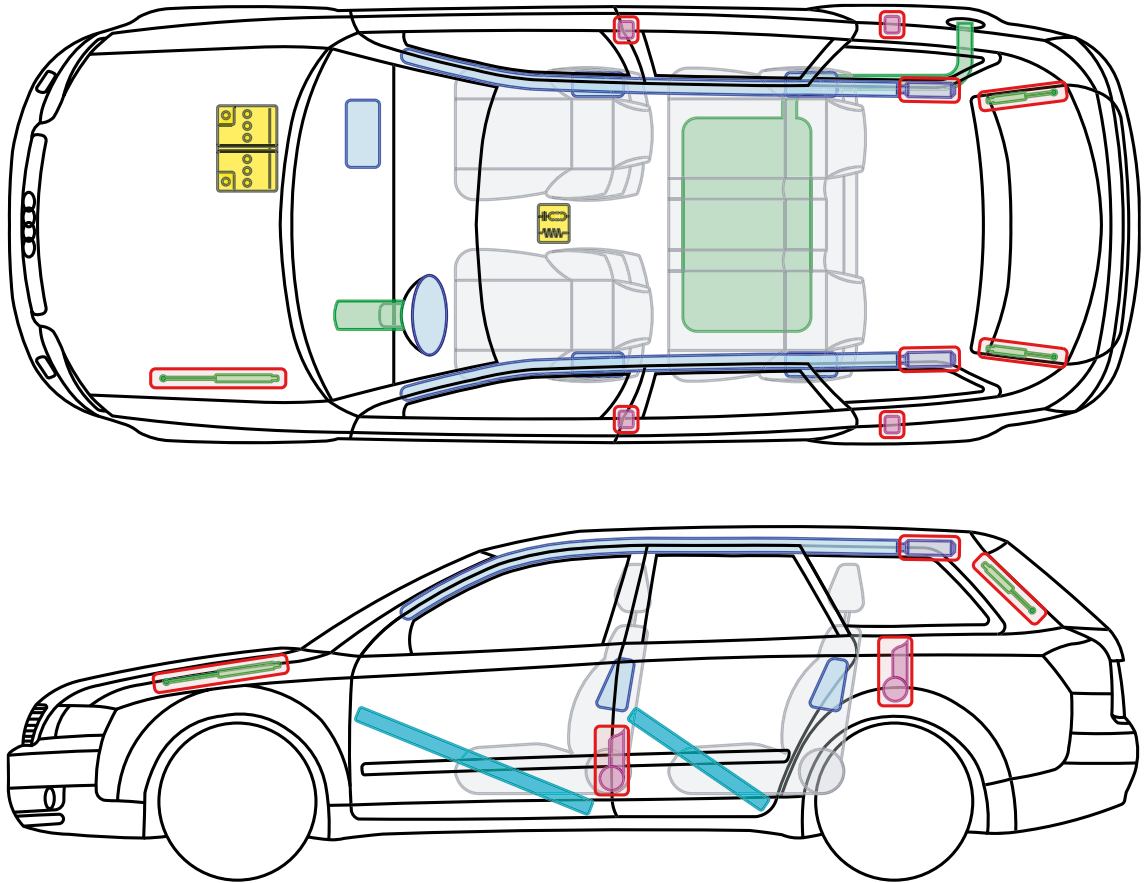

Legend

	Airbag		Reinforcement		Control module
	Gas generator		Rollover protection		Battery
	Pre-tensioner		Gas-pressure damper		Fuel tank







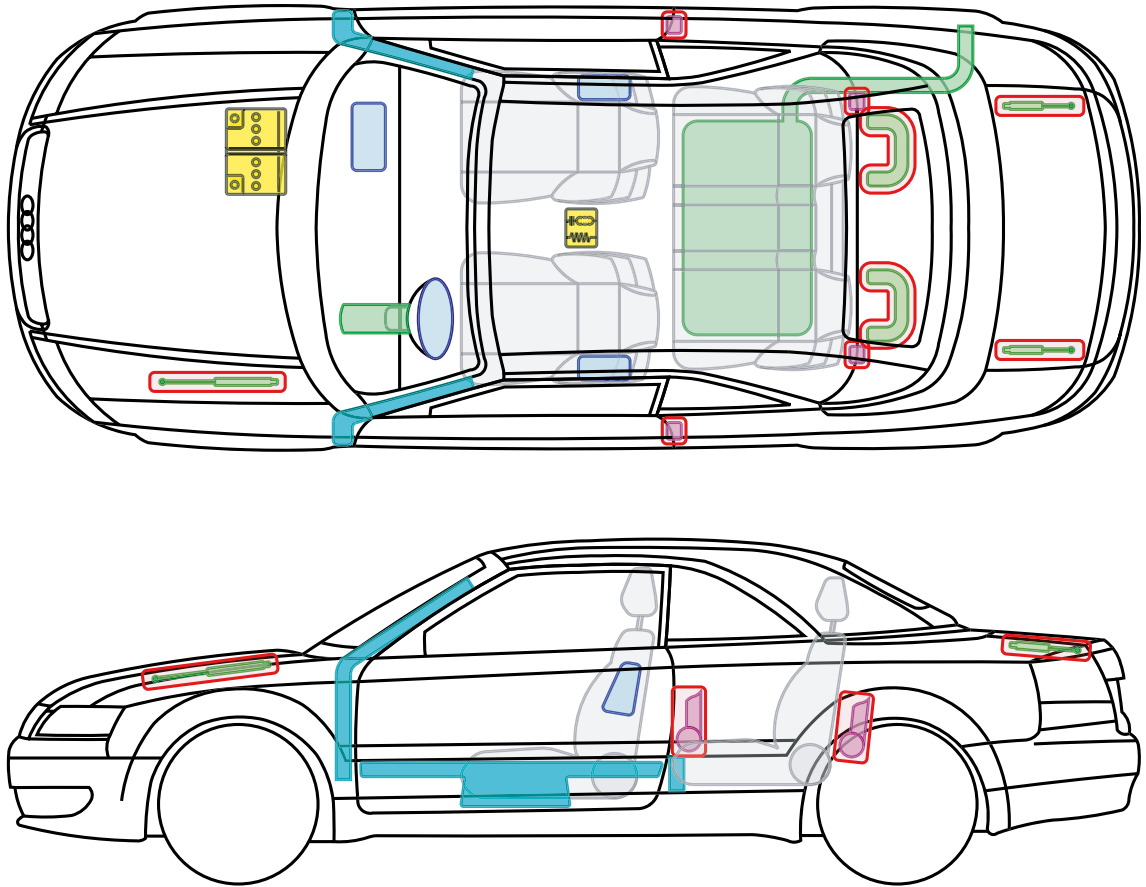

▶ Audi A4 / S4 Cabriolet

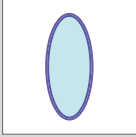
2002 – 2005

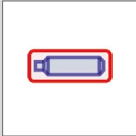

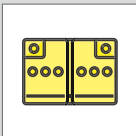
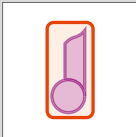
Legend

	Airbag		Reinforcement		Control module
	Gas generator		Rollover protection		Battery
	Pre-tensioner		Gas-pressure damper		Fuel tank

A4 + S4 Cabriolet



▶ Audi A4 / S4 / RS4

2005 – 2007

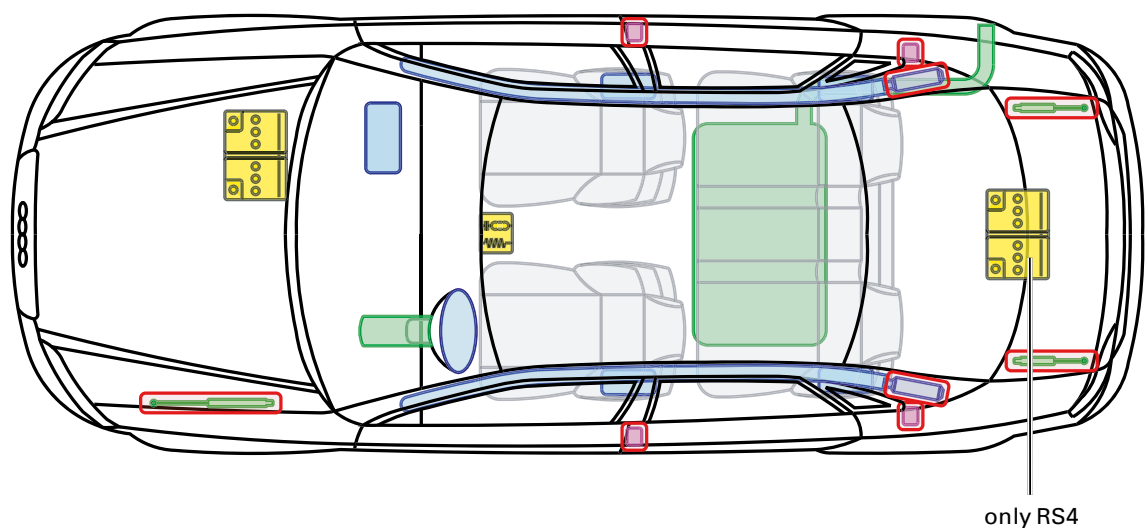

only RS4

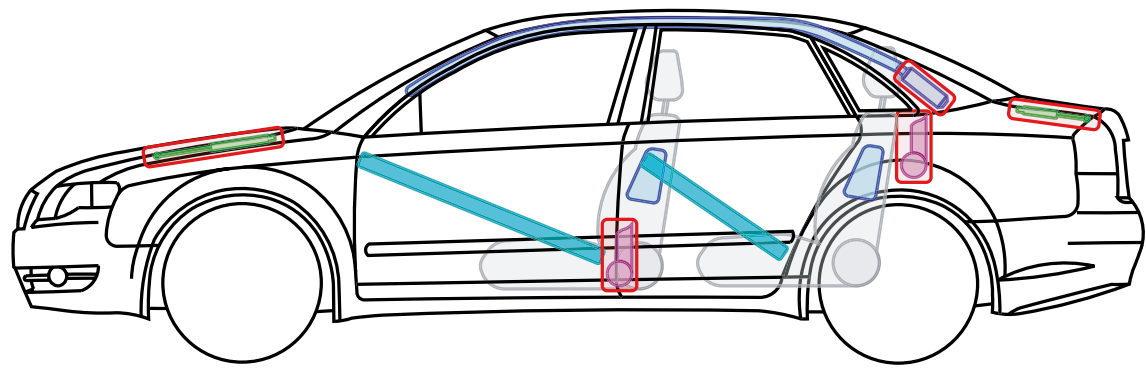

Legend

	Airbag		Reinforcement		Control module
	Gas generator		Rollover protection		Battery
	Pretensioner		Gas-pressure damper		Fuel tank

A4 + S4/RS4 Limousine



▶ Audi A4 / S4 / RS4 Avant



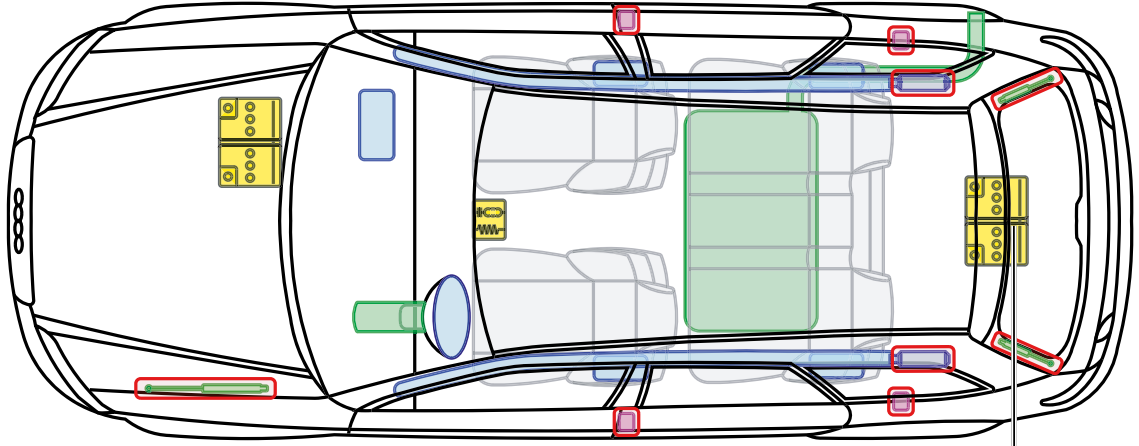

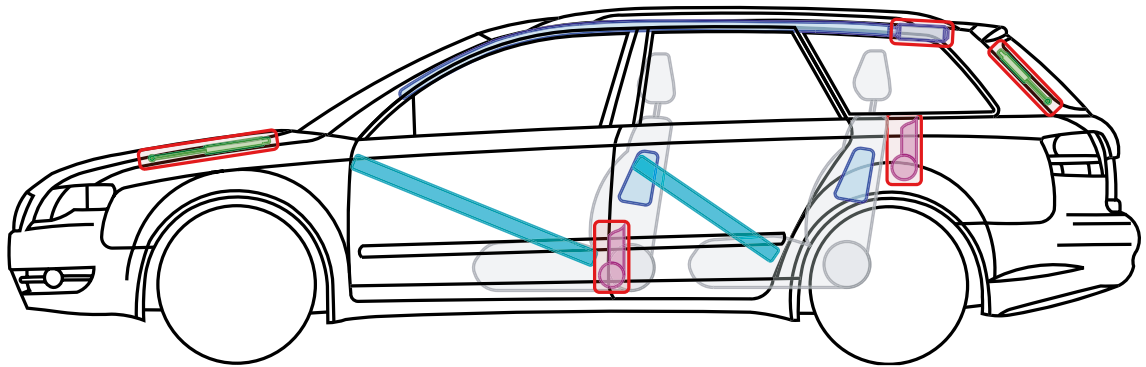

2005 – 2008

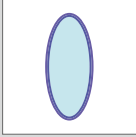

only RS4

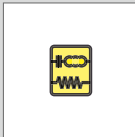
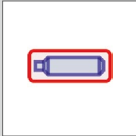

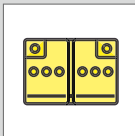
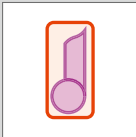
Legend

	Airbag		Reinforcement		Control module
	Gas generator		Rollover protection		Battery
	Pre-tensioner		Gas-pressure damper		Fuel tank

+ S4/RS4 Avant

A4



▶ Audi A4 / S4 / RS4 Cabriolet

2005 – 2009

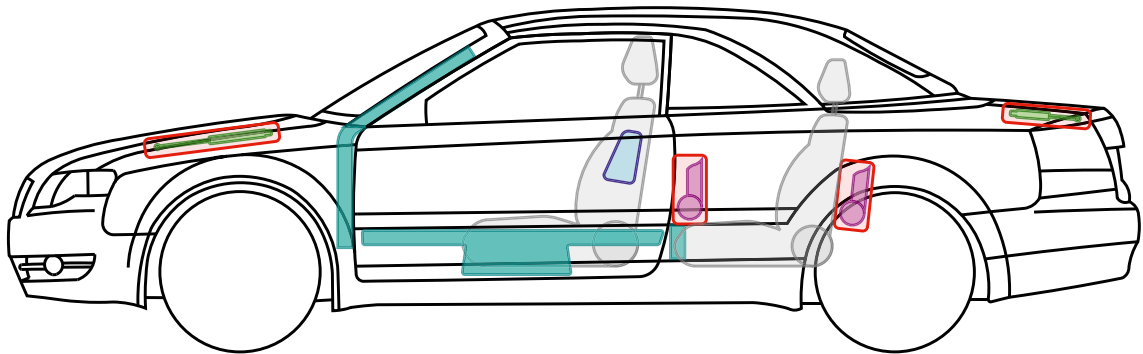
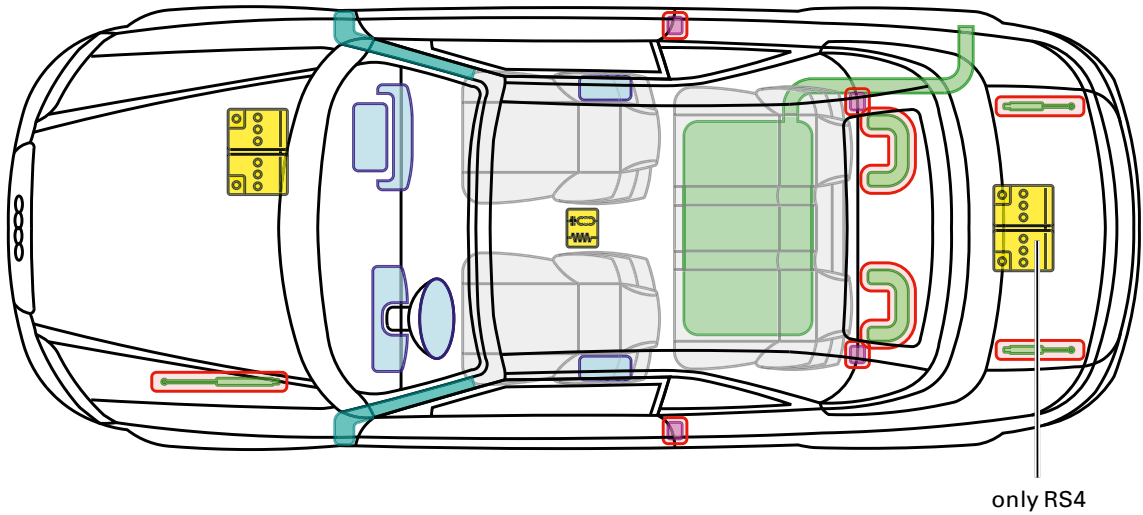

Legend

	Airbag		Reinforcement		Control module
	Gas generator		Rollover protection		Battery
	Pre-tensioner		Gas-pressure damper		Fuel tank

A4 + S4/RS4 Cabriolet



▶ Audi A6 / S6 / RS6

1997 – 2004

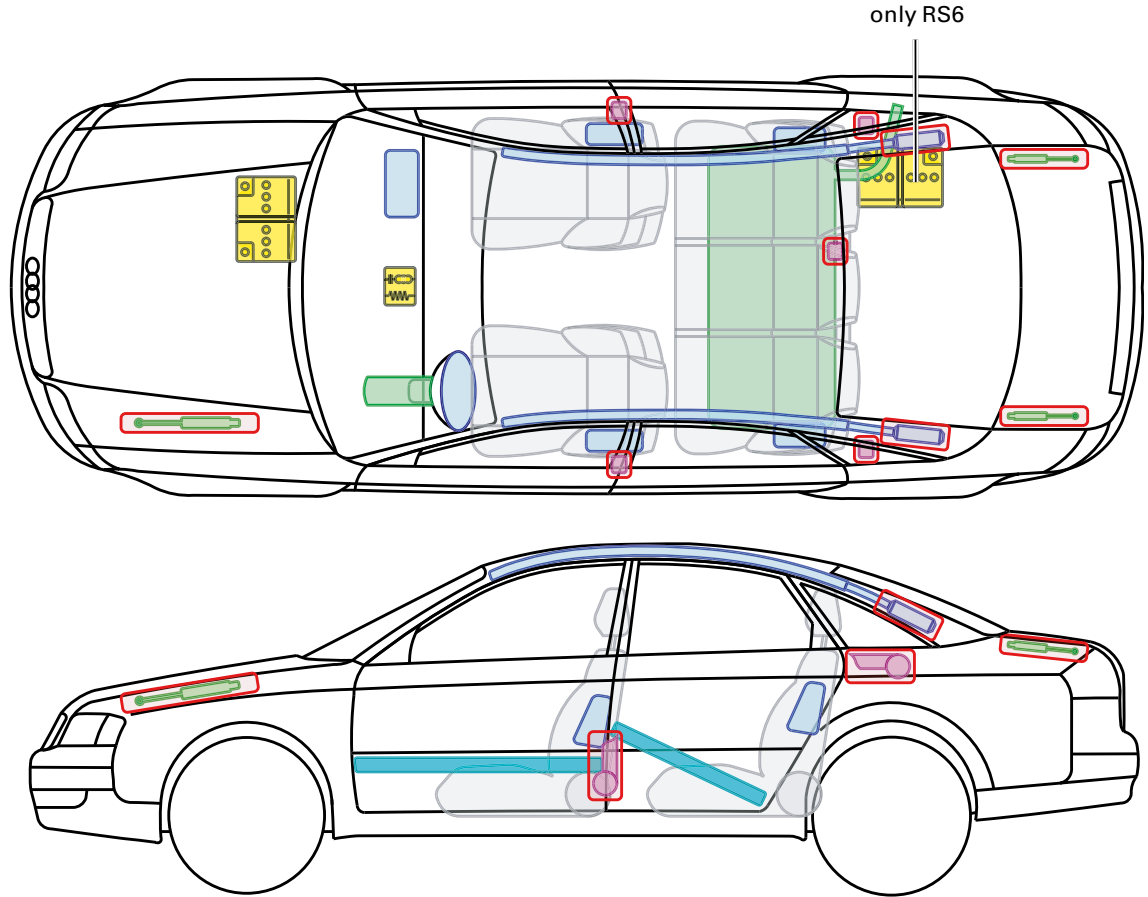

Legend

	Airbag		Reinforcement		Control module
	Gas generator		Rollover protection		Battery
	Pretensioner		Gas-pressure damper		Fuel tank









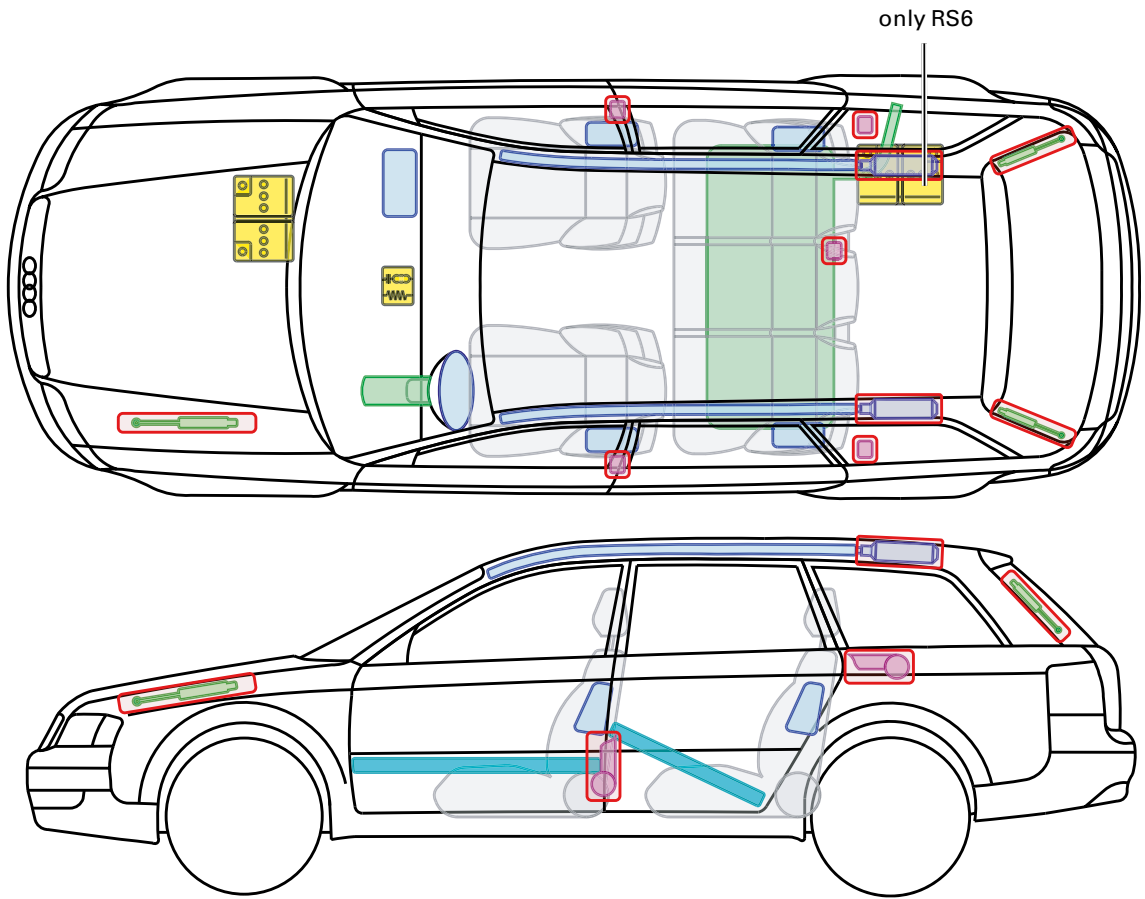

▶ Audi A6 / S6 / RS6 Avant

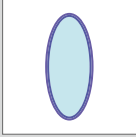
1998 – 2004

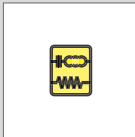
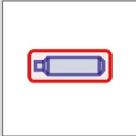

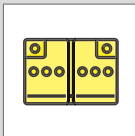
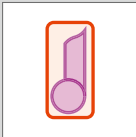
Legend

	Airbag		Reinforcement		Control module
	Gas generator		Rollover protection		Battery
	Pre-tensioner		Gas-pressure damper		Fuel tank

A6 + S6/RS6 Avant









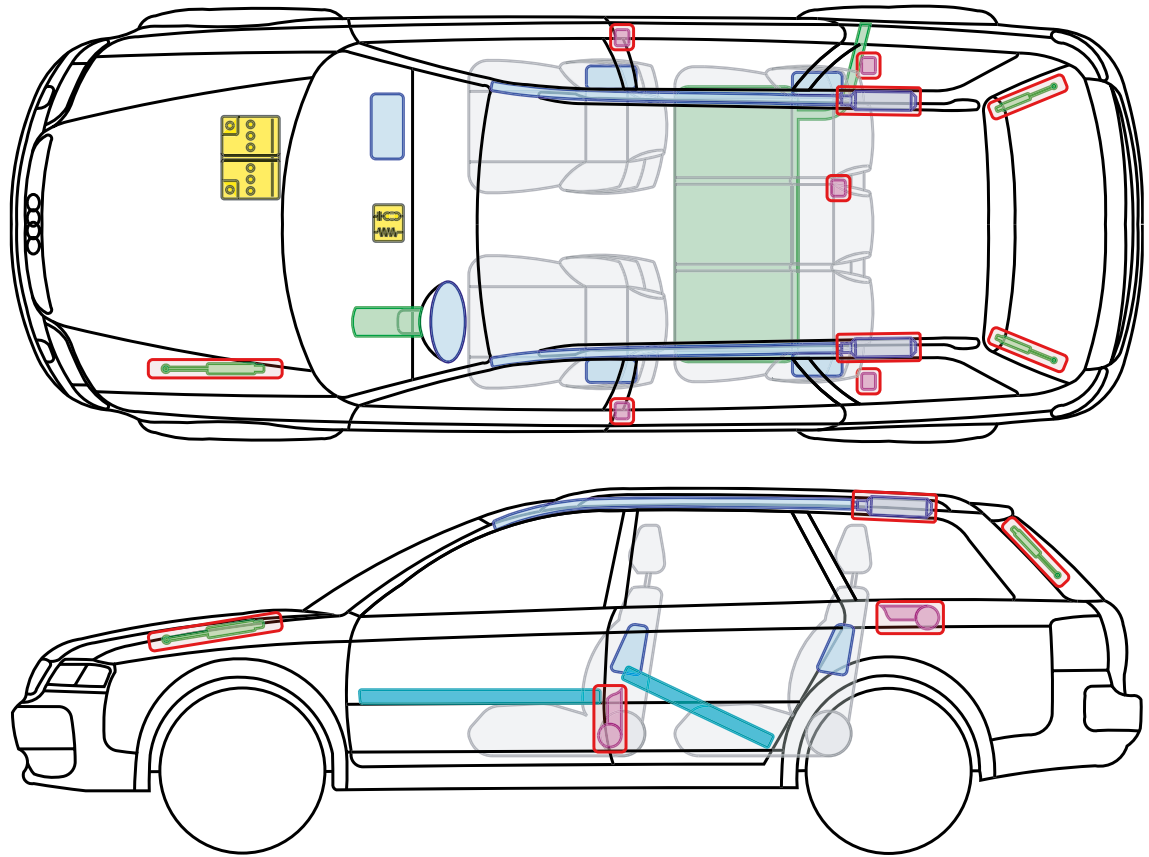

▶ Audi A6 allroad

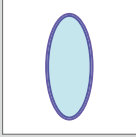
2001 – 2006

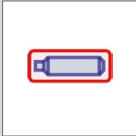

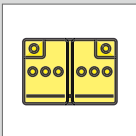
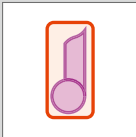
Legend

	Airbag		Reinforcement		Control module
	Gas generator		Rollover protection		Battery
	Pretensioner		Gas-pressure damper		Fuel tank









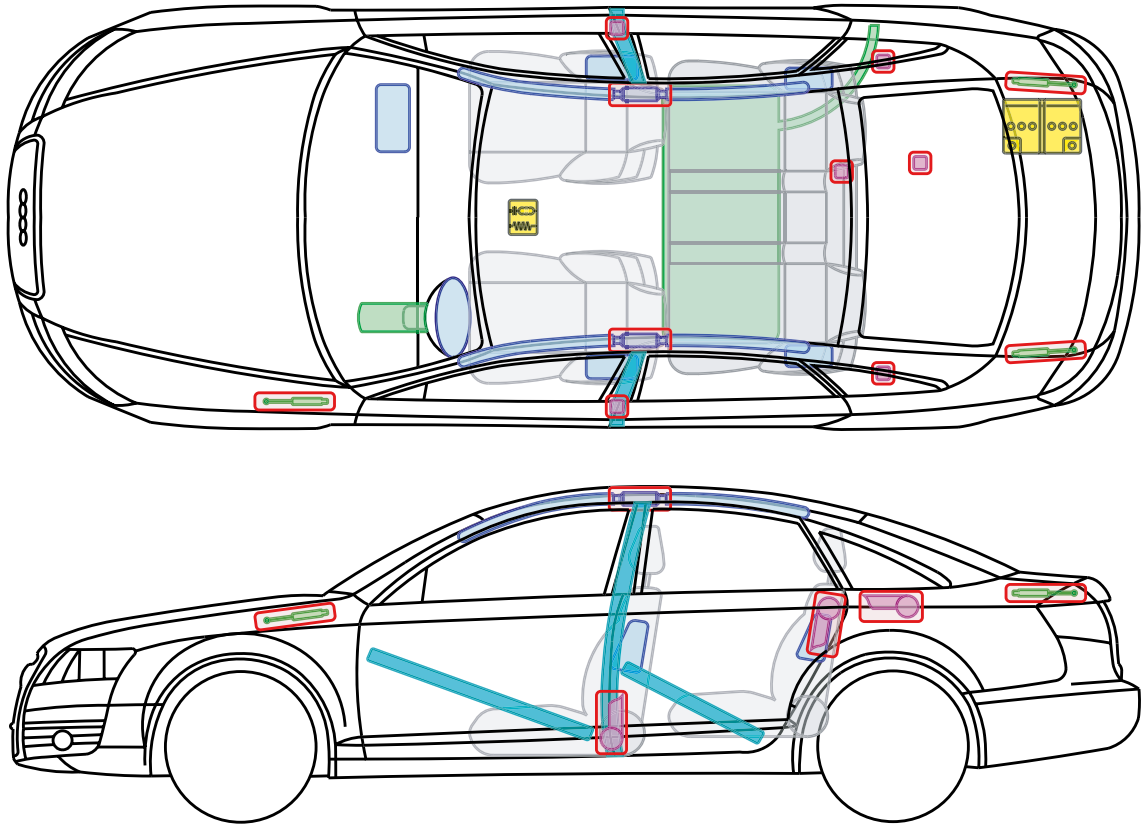

▶ Audi A6 / S6 / RS6

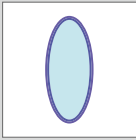
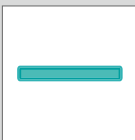
2004 – 2008

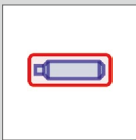

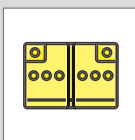
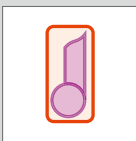
Legend

	Airbag		Reinforcement		Control
	Gas generator		Rollover protection		Battery
	Pre-tensioner		Gas-pressure damper		Fuel tank

A6 + S6/RS6 Limousine









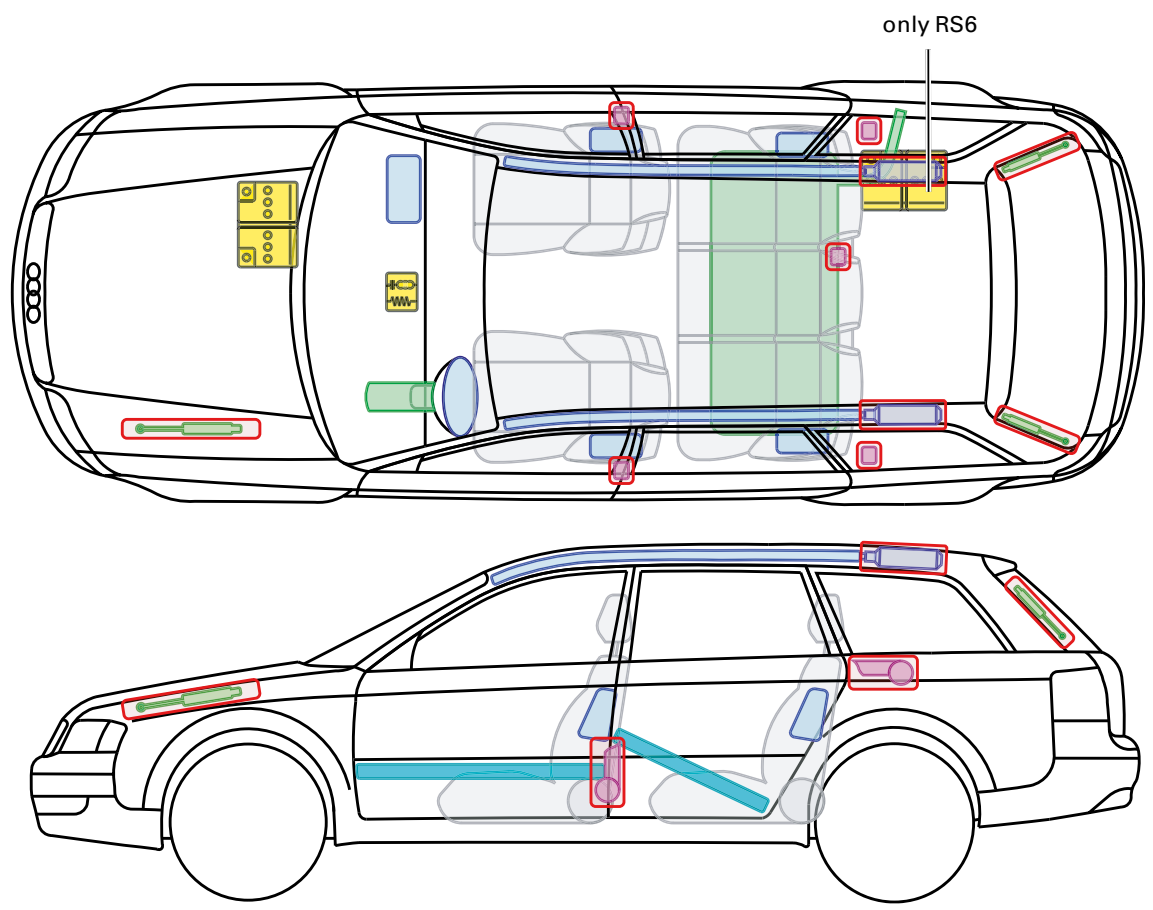

▶ Audi A6 / S6 / RS6 Avant

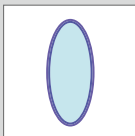
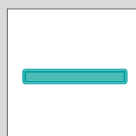
1998 – 2004

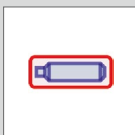

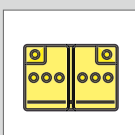
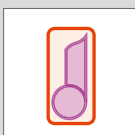
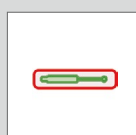
Legend

	Airbag		Reinforcement		Control module
	Gas generator		Rollover protection		Battery
	Pretensioner		Gas-pressure damper		Fuel tank

A6 + S6/RS6 Avant

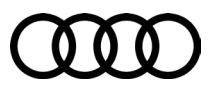



▶ Audi A8 / S8

1994 – 2002

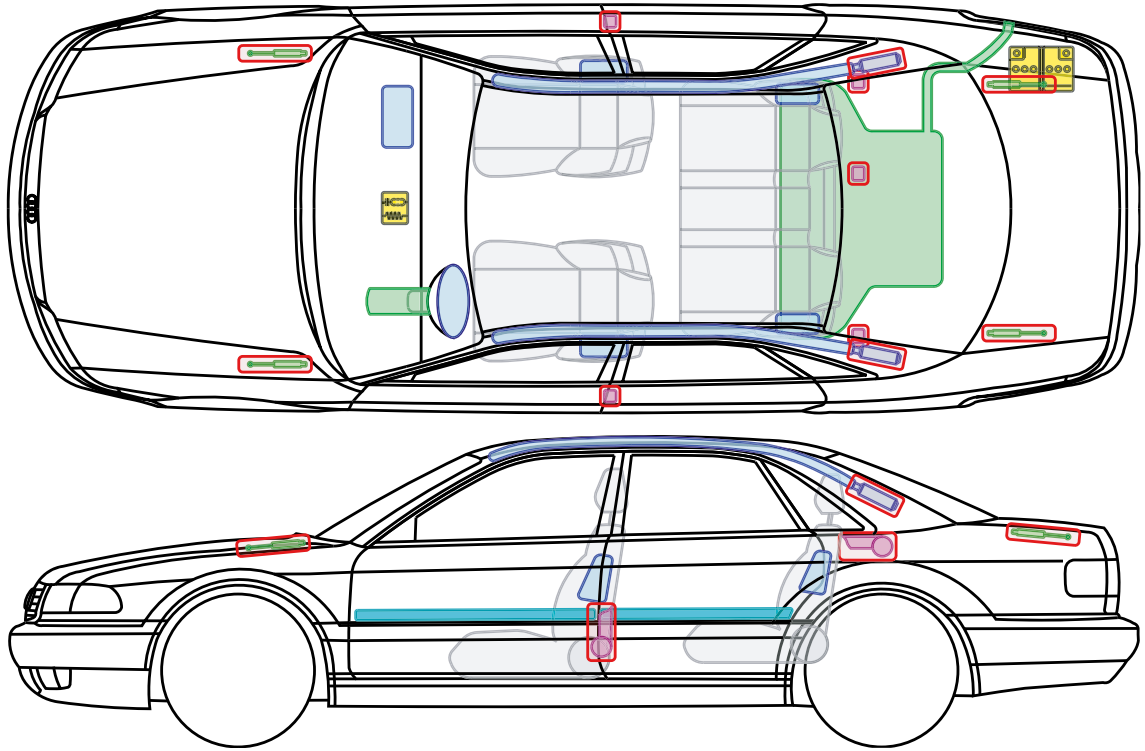

Legend

	Airbag		Reinforcement		Control module
	Gas generator		Rollover protection		Battery
	Pretensioner		Gas-pressure damper		Fuel tank









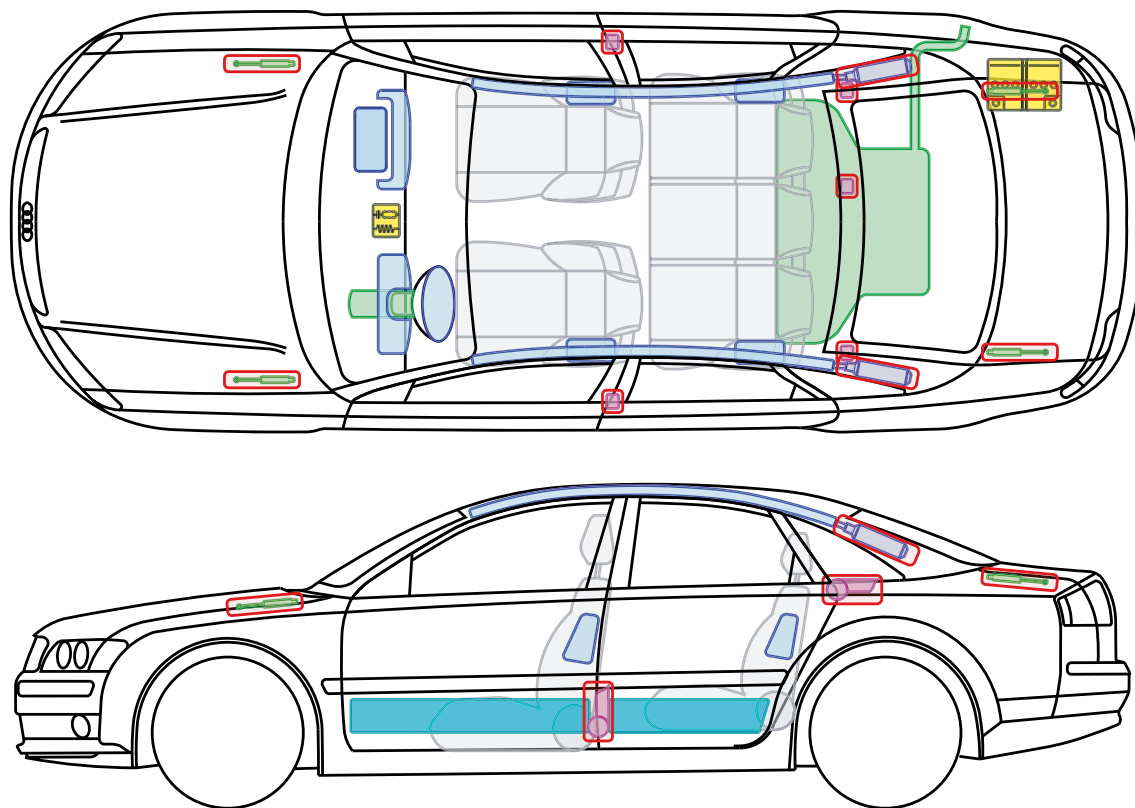

▶ Audi A8 / S8

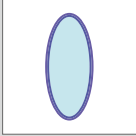
2002 – 2010

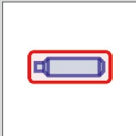

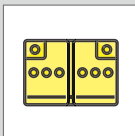
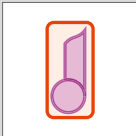
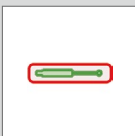
Legend

	Airbag		Reinforcement		Control module
	Gas generator		Rollover protection		Battery
	Pretensioner		Gas-pressure damper		Fuel tank









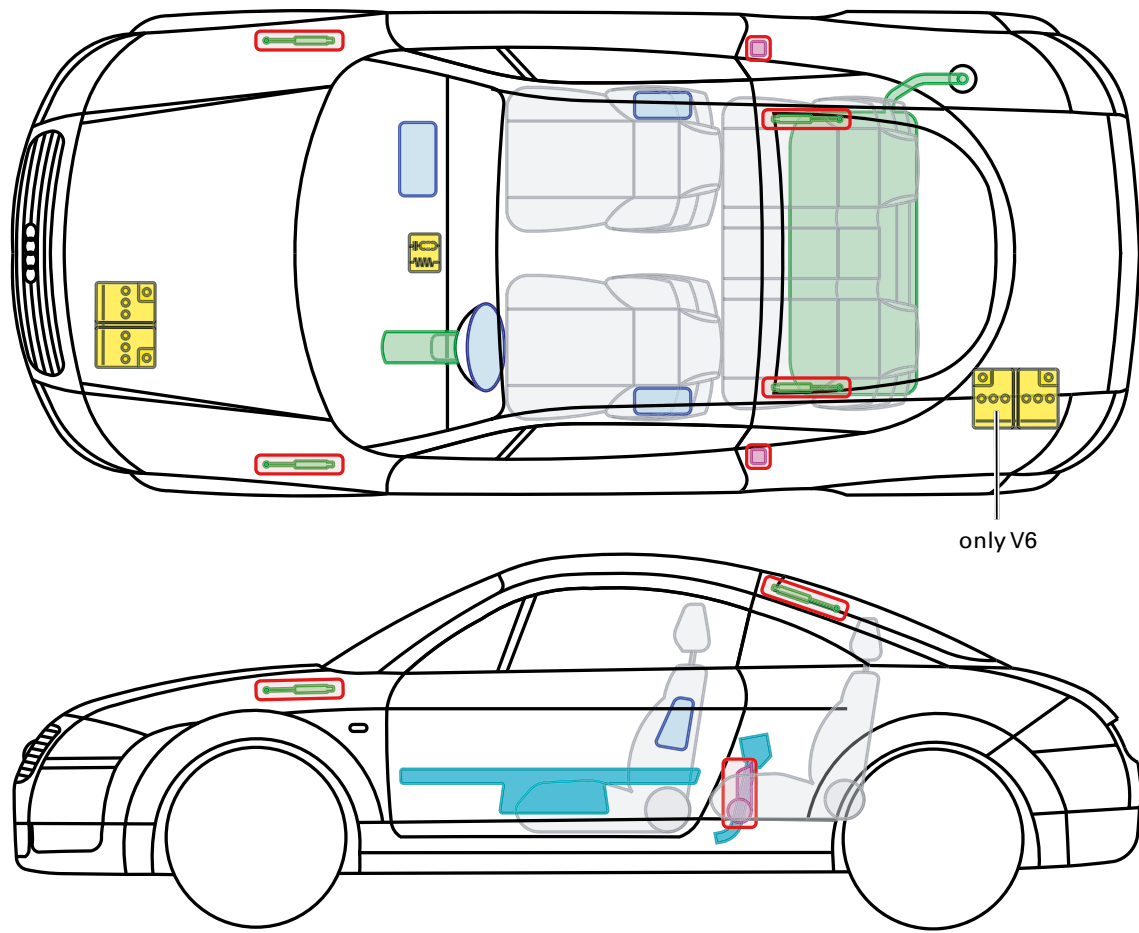

▶ Audi TT Coupé

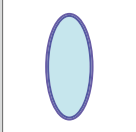
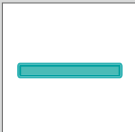
1998 – 2006

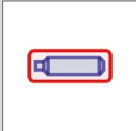

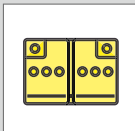
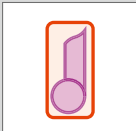
Legend

	Airbag		Reinforcement		Control module
	Gas generator		Rollover protection		Battery
	Pre-tensioner		Gas-pressure damper		Fuel tank







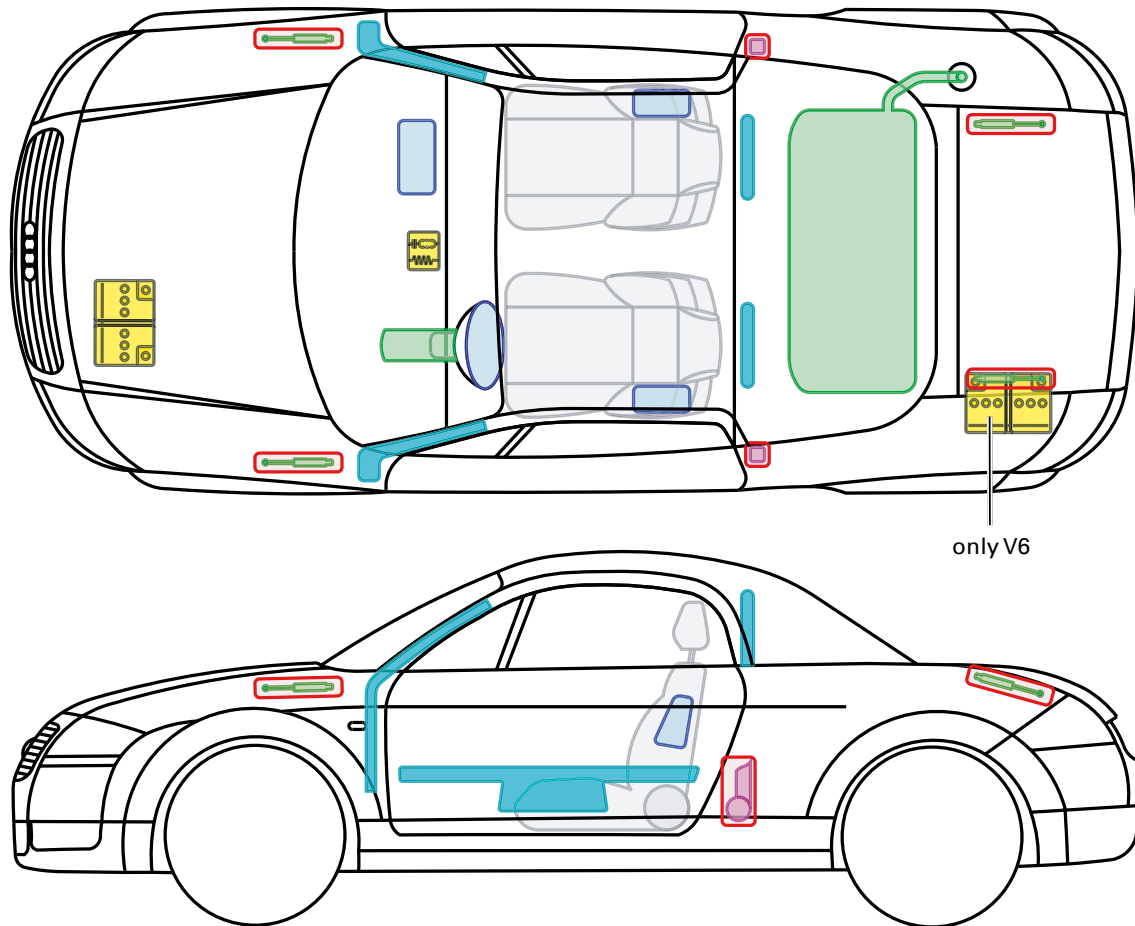

▶ Audi TT Roadster

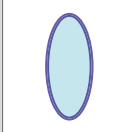
1999 – 2006

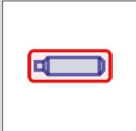

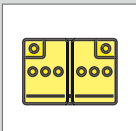
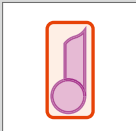
Legend

	Airbag		Reinforcement		Control module
	Gas generator		Rollover protection		Battery
	Pre-tensioner		Gas-pressure damper		Fuel tank