



# Audi Q8 / SQ8 e-tron

SUV inkl. Sportback, 2023-2025



kun på høyrestyrte biler

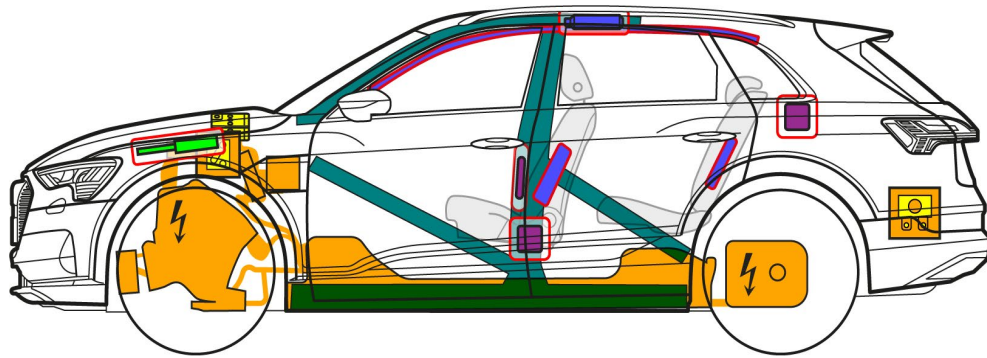
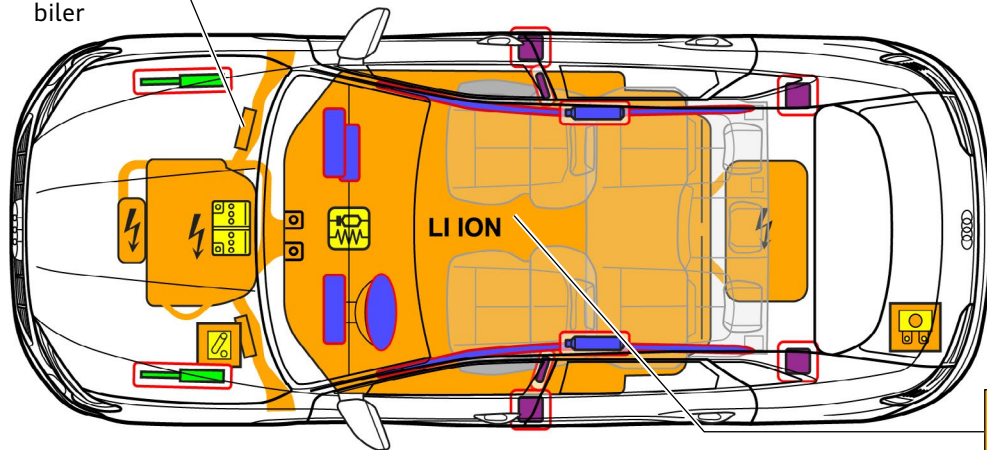

	Kollisjonspute		Gassgenerator		Beltestrammere		SRS-styreenhet		Gasstrykkfjær / forspent fjær
	Høyfaste områder		Lavvoltbatteri		Høyenergibatteri		Høyvoltledning		Høyvoltfrakobling, lavvoltage system
	Sikringsboks, deaktivering av høyvoltage system til lavvoltage		Høyvoltkomponent						



# Audi Q8 / SQ8 e-tron

## SUV inkl. Sportback, 2023-2025

### 1. Identifisering/gjenkjenning



Elektromotoren er lydløs. Visningen i kombiinstrumentet (effektmåleren) viser om den elektriske driften er slått av "OFF" eller driftsklar "READY".

Ladekontakt



Logo/modellbetegnelse (kan velges bort)



Q8



Q8 e-tron



Q8 e-tron Sportback

### 2. Fiksering/stabilisering/løfting

Gjøre bilen ubevegelig

Trykk på parkeringstasten "P" og aktiver parkeringsbremsen.



Løftepunkter

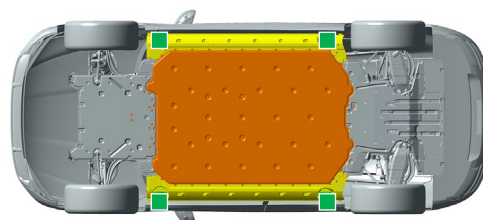

Egnede løftepunkter

Høyenergibatteri

Slå av tenningen (effektmåleren viser "OFF")



Trykk på START-STOP-tasten uten å trå inn bremsepedalen.



I stedet for en fjernkontrollnøkkel er det også mulig å bruke et nøkkelkort eller en smarttelefonapp.

### 3. Eliminere direkte farer / sikkerhetsbestemmelser

Ved ulykker med kollisjonsputeutløsning deaktiveres høyvoltsystemet automatisk umiddelbart etter at kollisjonsputeutløsningen er registrert. Høyvoltsystemet er spenningsfritt ca. 20 sekunder etter deaktiveringen.



Ikke berør, skjær i eller åpne skadde høyvoltkomponenter, -ledninger eller høyenergibatterier! Bruk egnet verneutstyr!

I alle andre tilfeller kan høyvoltsystemet deaktiveres på følgende måte:

Mulighet 1: fra motorrommet

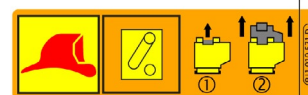
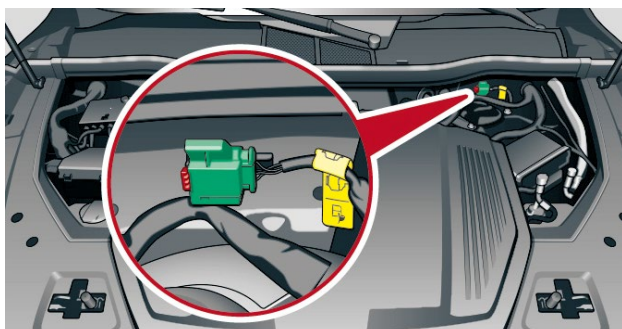
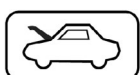

① Trekk ut den røde fliken.

② Trekk ut den sorte stikkeren.





# Audi Q8 / SQ8 e-tron

## SUV inkl. Sportback, 2023-2025

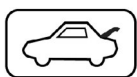

### Mulighet 2: (sikring i bagasjerommet)

Løft gulvet.

Ta av dekslet.

Trekk ut sikringen.

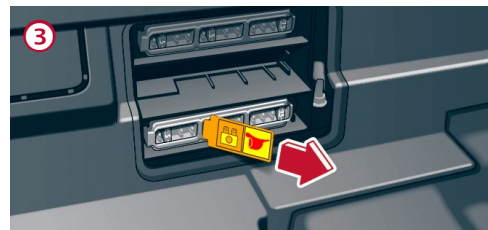
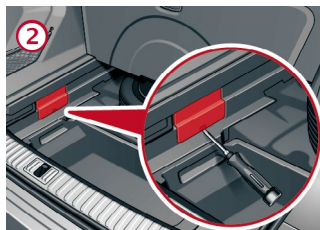
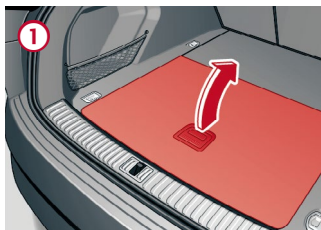

### Koble fra 12-voltsbatteriet

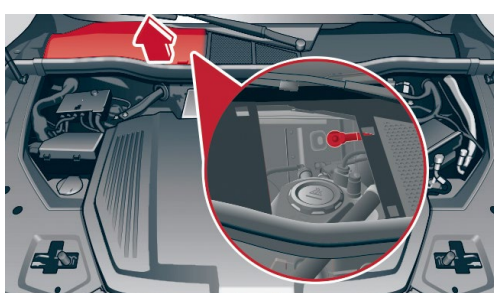

12-voltsbatteriet er plassert foran i bilen under dekslet til vannfangrommet.

Batteriets godsledning er skrudd fast til karosseriet ved vannfangrommets fremre vegg. Her kan batteriets godsforbindelse (minuspol) kobles fra kontaktpunktet på karosseriet.

### Koble fra ladestasjon (nødopplåsing av ladestøpsel)

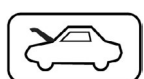

Ta av dekslet.

Trekk i den gule hempen.

Trekk ut ladestøpslet.

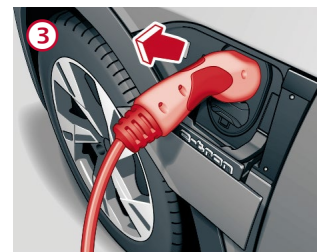
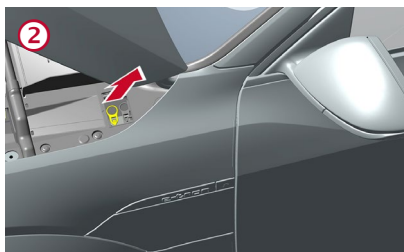
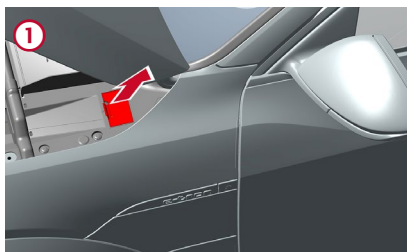

## 4. Tilgang til personene i bilen

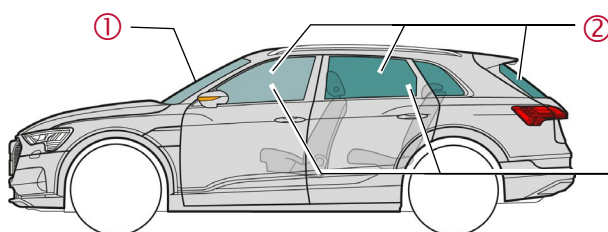

### Glasstyper:

- ① Flerlags sikkerhetsglass
- ② Ettlags sikkerhetsglass
- ③ Eventuelt flerlags sikkerhetsglass i sidevindue



# Audi Q8 / SQ8 e-tron

## SUV inkl. Sportback, 2023-2025

### 5. Lagret energi / væsker / gasser / faststoffer



12 V



400 V  
litium-ion



Hvis det lekker kjølevæske fra batterikjølesystemet, er det fare for en termisk reaksjon i høyenergibatteriet. Overvåk høyenergibatteriets temperatur!



### 6. Ved brann



Ved skader eller feil bruk kan litium-ion-batterier selvantenne eller antennes på nytt etter at brannen er slukket! Dette kan skje innen kort tid eller også etter at det har gått en stund. Bruk egnet verneutstyr!



### 7. Under vann

Deaktiver høyvoltsystemet (se kapittel 3) etter at bilen er berget fra vannet, og la vannet renne ut. Bruk egnet verneutstyr!

### 8. Tauing/transport/lagring



Litium-ion-batterier kan selvantenne eller antennes på nytt etter at brannen er slukket! Bruk egnet verneutstyr!

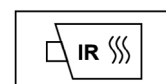

For biler som har vært i en ulykke, og/eller hvis høyenergibatteriet er skadet eller noe ved høyenergibatteriet er påfallende: deaktiver høyvoltsystemet (se kapittel 3). Parker bilen i sikker avstand på minst 5 meter fra bygninger og andre kjøretøyer (karanteneområde).



En bil som har vært i en ulykke, skal ikke taues på drivakslene.

### 10. Betydningen til piktogrammene



Brannfarlig



Etsende, irriterer huden



Kronisk helsefare



Miljøfare



Elektrisk kjøretøy



Advarsel, høyspenning



Advarsel, fare



Slukk med vann



Farlig spenning



Fjern smartnøkkel

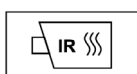

Bruk infrarødt varmebildekamera



Lås opp panser

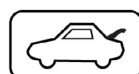

Lås opp bagasjerom