







Modellbezeichnung	Modellzyklus	Seite
 Audi 80		
Audi 80 / S2	1990 – 1995	3
Audi 80 / S2 / RS2 Avant	1992 – 1995	4
Audi 80 / S2 Coupé	1988 – 1996	5
Audi 80 Cabriolet	1991 – 2000	6
 Audi 100		
Audi 100	1988 – 1991	7
Audi 100 Avant	1988 – 1991	8
Audi 100 / A6 / S6	1991 – 1997	9
Audi 100 / A6 / S6 Avant	1991 – 1997	10
 Audi 200		
Audi 200 / V8	1984 – 1991	11
Audi 200 Avant	1985 – 1991	12
 Audi A2		
Audi A2	2000 – 2005	13
 Audi A3		
Audi A3 (5-Türer)	1999 – 2003	14
Audi A3 / S3 (3-Türer)	1996 – 2003	15
Audi A3 / S3 (3-Türer)	2003 – 2012	16
Audi A3 / S3 / RS3 Sportback	2004 - 2013	17
 Audi A4		
Audi A4 / S4	1995 – 2001	18
Audi A4 / S4 / RS4 Avant	1996 – 2001	19
Audi A4 / S4	2001 – 2005	20
Audi A4 / S4 Avant	2001 – 2005	21
Audi A4 / S4 Cabriolet	2002 – 2005	22
Audi A4 / S4 / RS4	2005 – 2007	23
Audi A4 / S4 / RS4 Avant	2005 – 2008	24
Audi A4 / S4 / RS4 Cabriolet	2005 – 2009	25

Audi A6

Audi A6 / S6 / RS6	1997–2004	26
Audi A6 / S6 / RS6 Avant	1998–2004	27
Audi A6 allroad	2001–2006	28
Audi A6 / S6 / RS6	2004–2008	29
Audi A6 / S6 / RS6 Avant	2004–2012	30

Audi A8

Audi A8 / S8	1994–2002	31
Audi A8 / S8	2002–2010	32

Audi TT

Audi TT Coupé	1998–2006	33
Audi TT Roadster	1999–2006	34

Rechtlicher Hinweis:

Diese Rettungsdatenblätter wurden ausschließlich für Rettungskräfte erstellt, die über eine spezielle Ausbildung auf dem Gebiet der technischen Hilfeleistung nach Verkehrsunfällen verfügen. Des Weiteren zeigen die Rettungsdatenblätter immer die maximal mögliche Ausstattung eines Fahrzeugs.

Spezifikationen und Sonderausstattungen der Fahrzeuge sowie das Fahrzeugangebot der AUDI AG unterliegen stetig etwaigen Änderungen. Daher behält sich Audi inhaltliche Anpassungen bzw. Änderungen an diesem Dokument jederzeit ausdrücklich vor.

Beachten Sie bitte: Die in diesem Leitfaden enthaltenen Informationen sind nicht für Endkunden und ebenfalls nicht für Werkstätten und Händler bestimmt. Endkunden können den Bordbüchern ihres jeweiligen Audi Fahrzeuges detaillierte Informationen zu den Funktionen ihres Fahrzeuges sowie wichtige Sicherheitshinweise zur Fahrzeug- und Insassensicherheit entnehmen. Werkstätten und Händler erhalten Reparaturinformationen über die ihnen bekannten Bezugsquellen.

(Stand: 09/2019)



Hinweis:

In den Modellübersichten ist immer die maximal mögliche Ausstattung eines Fahrzeugs gezeigt.

Einen allgemeinen Teil mit „Hinweise(n) zur Unfallrettung aus verunfallten Audi Fahrzeugen“ finden Sie in gleichnamiger Broschüre.

Die Erstellung des Rettungsleitfadens erfolgt mit freundlicher Unterstützung durch Moditech Rescue Solutions (www.moditech.com). Die gezeigten Fahrzeugübersichten sind in interaktiver Form auch in der Datenbank „Crash Recovery System“ enthalten.

Dieses Dokument unterliegt dem Copyright der AUDI AG, Ingolstadt. Jede Vervielfältigung, Verbreitung, Speicherung, Übermittlung, Sendung und Wieder- bzw. Weitergabe der Inhalte ist ohne schriftliche Genehmigung der AUDI AG ausdrücklich untersagt.



▶ Audi 80 / S2

1990 – 1995

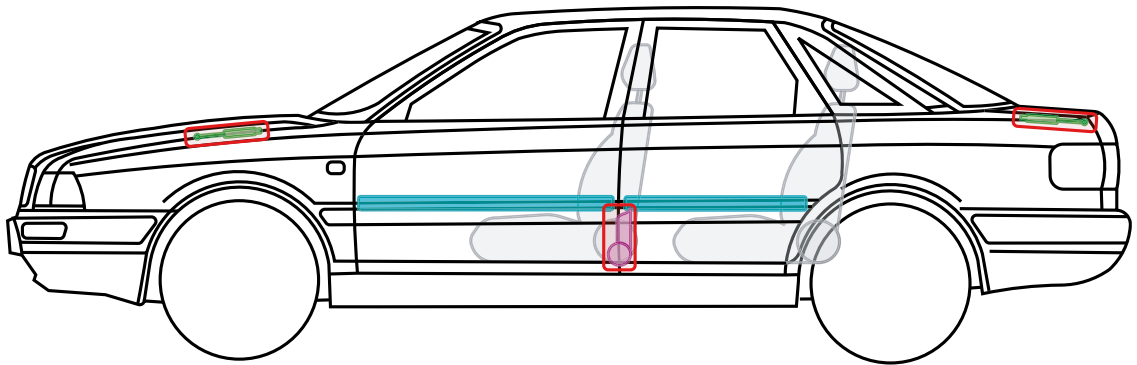
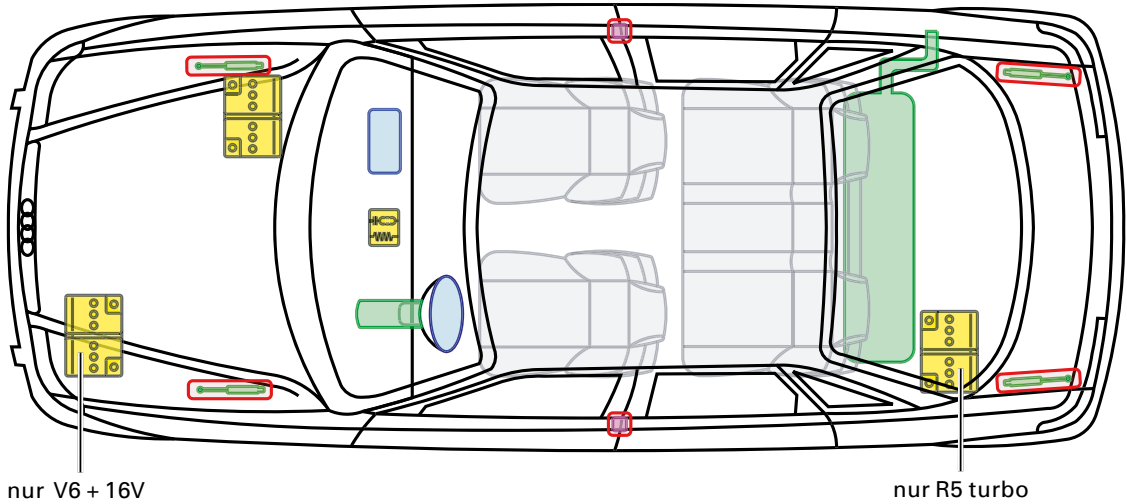

Legende

	Airbag		Karosserie- verstärkung		Steuergerät
	Gas- generator		Überroll- schutz		Batterie
	Gurt- straffer		Gasdruck- dämpfer		Kraftstoff- tank

Dieses Dokument unterliegt dem Copyright der AUDI AG, Ingolstadt. Jede Vervielfältigung, Verbreitung, Speicherung, Übermittlung, Sendung und Wieder- bzw. Weitergabe der Inhalte ist ohne schriftliche Genehmigung der AUDI AG ausdrücklich untersagt.



▶ Audi 80 / S2 / RS2 Avant

1992 – 1995

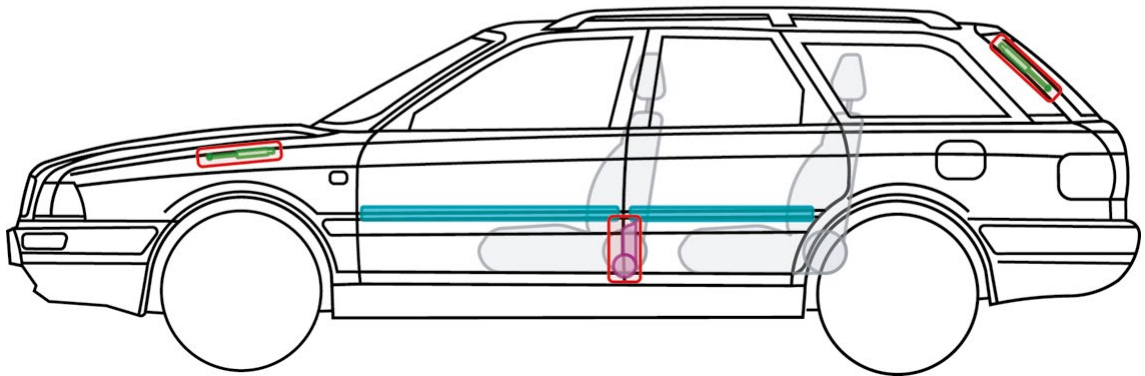
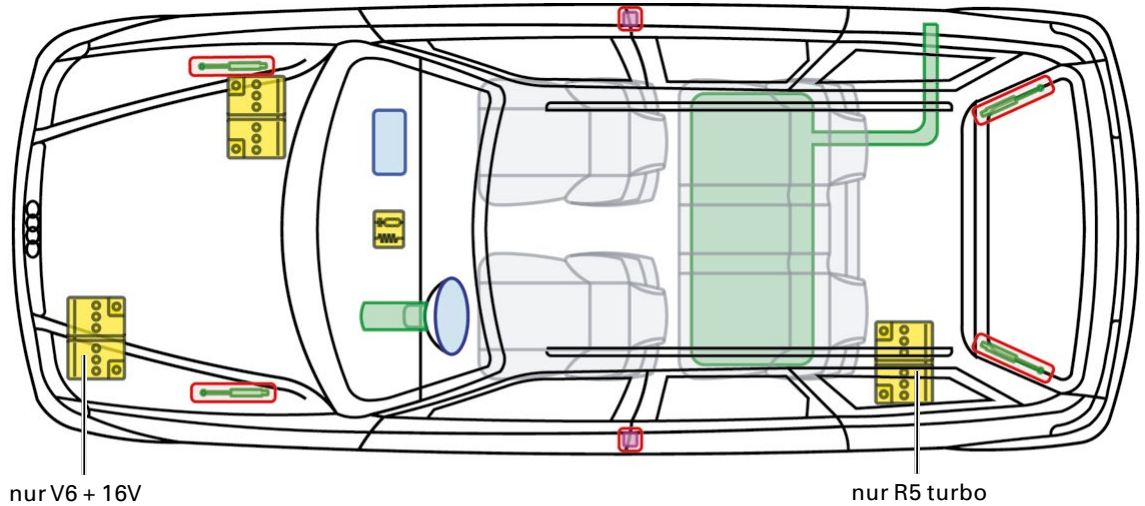

Legende

	Airbag		Karosserie- verstärkung		Steuergerät
	Gas- generator		Überroll- schutz		Batterie
	Gurt- straffer		Gasdruck- dämpfer		Kraftstoff- tank

Dieses Dokument unterliegt dem Copyright der AUDI AG, Ingolstadt. Jede Vervielfältigung, Verbreitung, Speicherung, Übermittlung, Sendung und Wieder- bzw. Weitergabe der Inhalte ist ohne schriftliche Genehmigung der AUDI AG ausdrücklich untersagt.



▶ Audi 80 / S2 Coupé

1988 – 1996

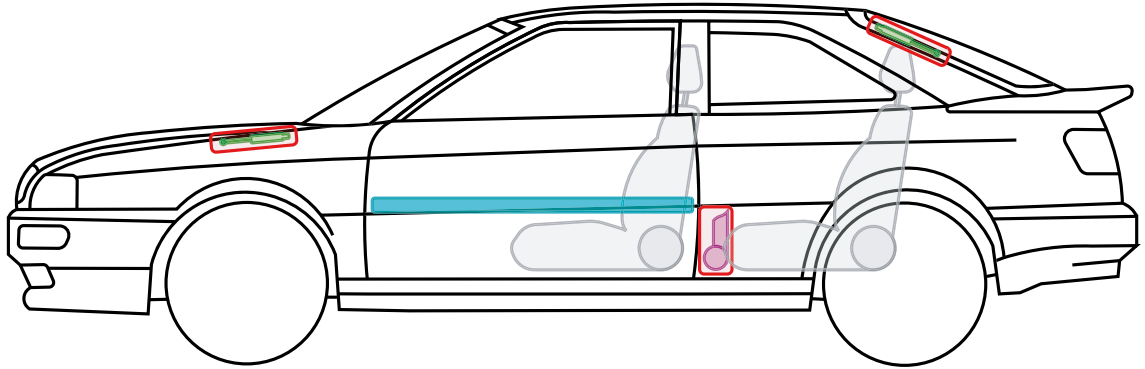
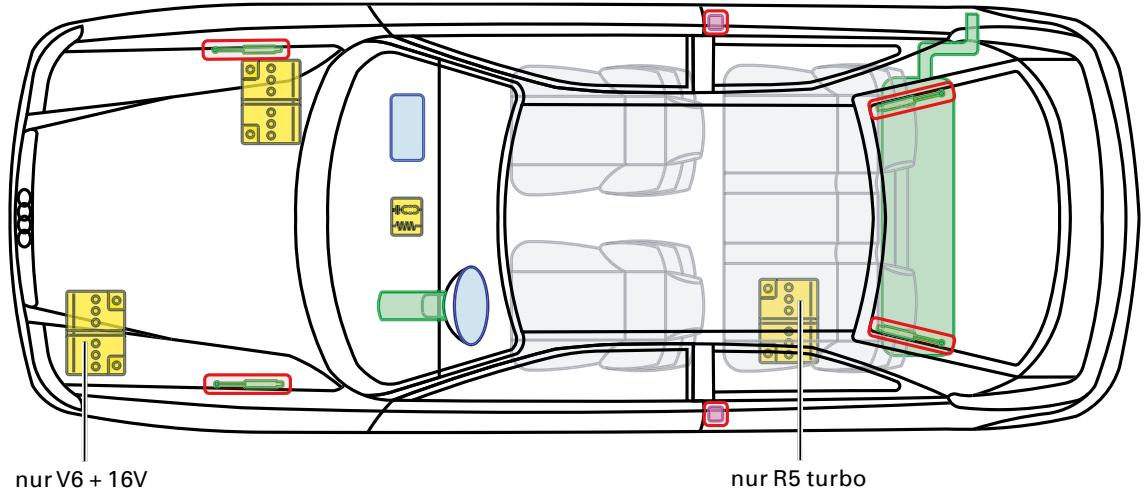

Legende

	Airbag		Karosserie- verstärkung		Steuergerät
	Gas- generator		Überroll- schutz		Batterie
	Gurt- straffer		Gasdruck- dämpfer		Kraftstoff- tank

Dieses Dokument unterliegt dem Copyright der AUDI AG, Ingolstadt. Jede Vervielfältigung, Verbreitung, Speicherung, Übermittlung, Sendung und Wieder- bzw. Weitergabe der Inhalte ist ohne schriftliche Genehmigung der AUDI AG ausdrücklich untersagt.



▶ **Audi 80 Cabriolet**



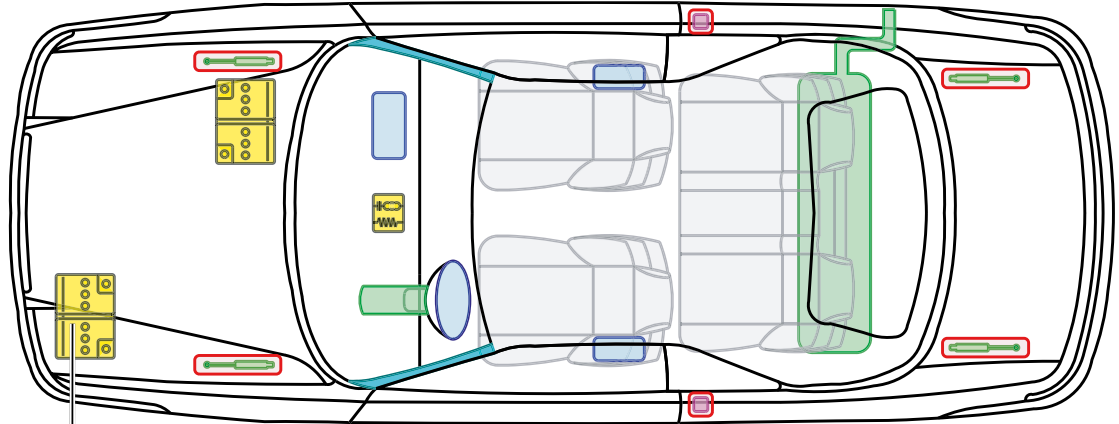

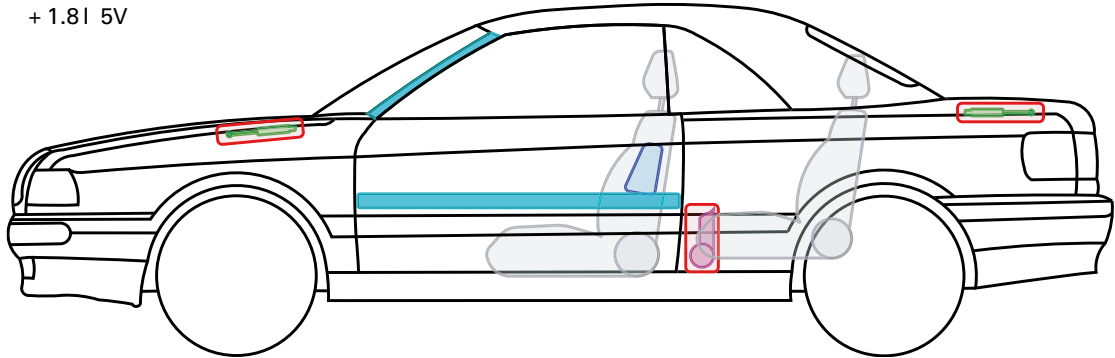

1991 – 2000

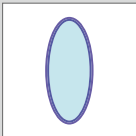
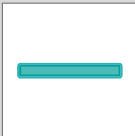

nur V6 + 16V
+ 1.8l 5V

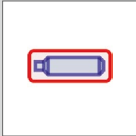

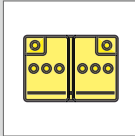
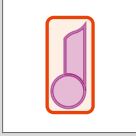
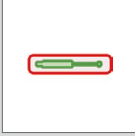
Legende

	Airbag		Karosserie- verstärkung		Steuergerät
	Gas- generator		Überroll- schutz		Batterie
	Gurt- straffer		Gasdruck- dämpfer		Kraftstoff- tank

Dieses Dokument unterliegt dem Copyright der AUDI AG, Ingolstadt. Jede Vervielfältigung, Verbreitung, Speicherung, Übermittlung, Sendung und Wieder- bzw. Weitergabe der Inhalte ist ohne schriftliche Genehmigung der AUDI AG ausdrücklich untersagt.



▶ Audi 100

1988 – 1991

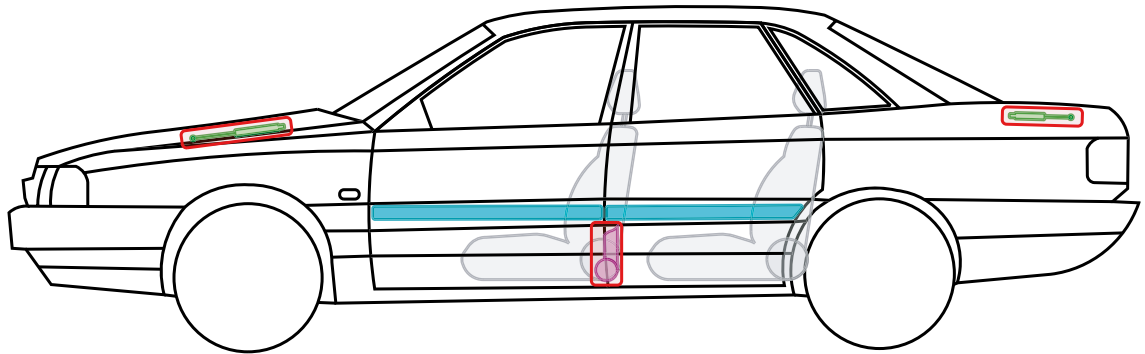
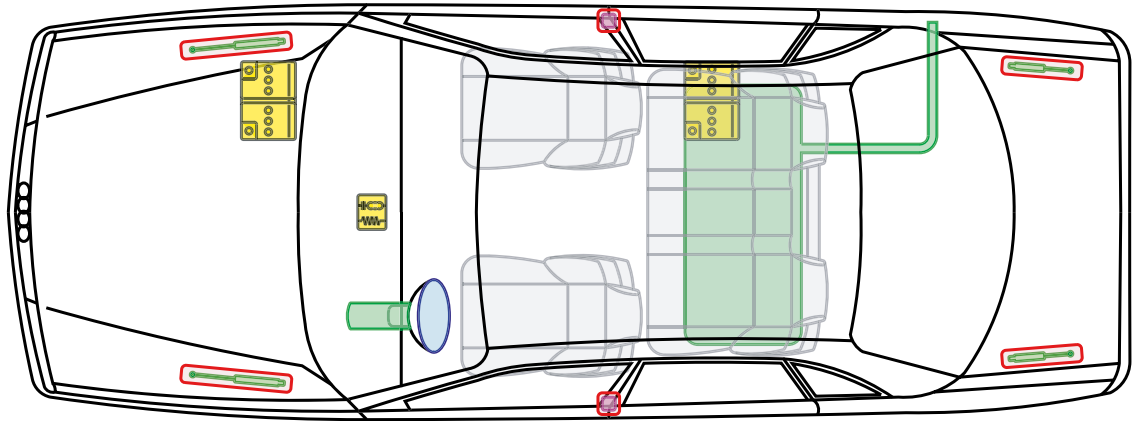

Legende

	Airbag		Karosserie- verstärkung		Steuergerät
	Gas- generator		Überroll- schutz		Batterie
	Gurt- straffer		Gasdruck- dämpfer		Kraftstoff- tank

Dieses Dokument unterliegt dem Copyright der AUDI AG, Ingolstadt. Jede Vervielfältigung, Verbreitung, Speicherung, Übermittlung, Sendung und Wieder- bzw. Weitergabe der Inhalte ist ohne schriftliche Genehmigung der AUDI AG ausdrücklich untersagt.







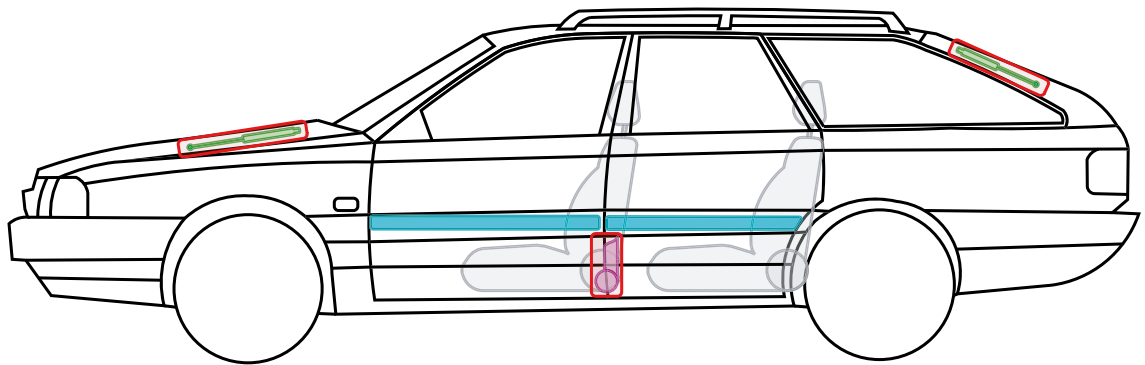
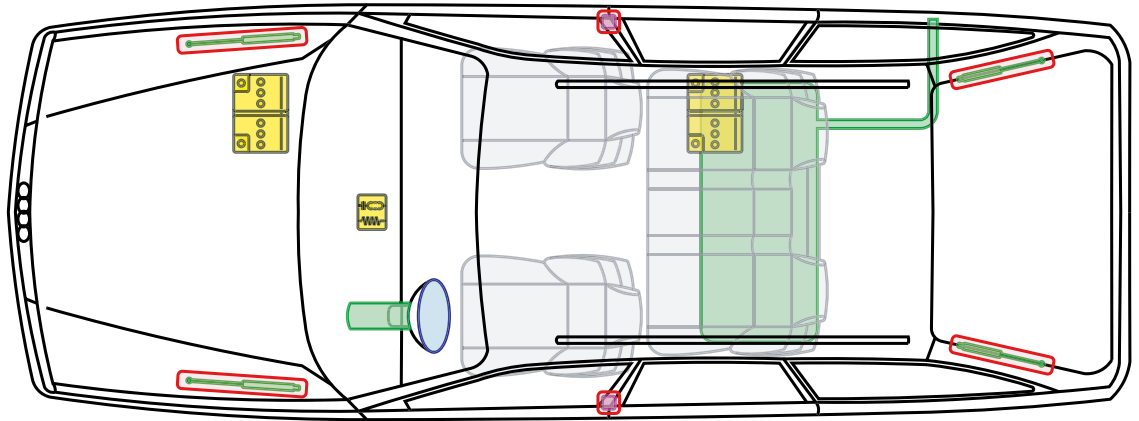

▶ Audi 100 Avant

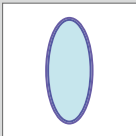
1988 – 1991

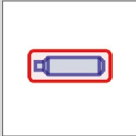

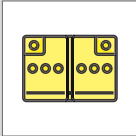
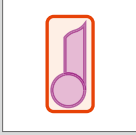
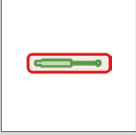
Legende

	Airbag		Karosserie- verstärkung		Steuergerät
	Gas- generator		Überroll- schutz		Batterie
	Gurt- straffer		Gasdruck- dämpfer		Kraftstoff- tank

Dieses Dokument unterliegt dem Copyright der AUDI AG, Ingolstadt. Jede Vervielfältigung, Verbreitung, Speicherung, Übermittlung, Sendung und Wieder- bzw. Weitergabe der Inhalte ist ohne schriftliche Genehmigung der AUDI AG ausdrücklich untersagt.







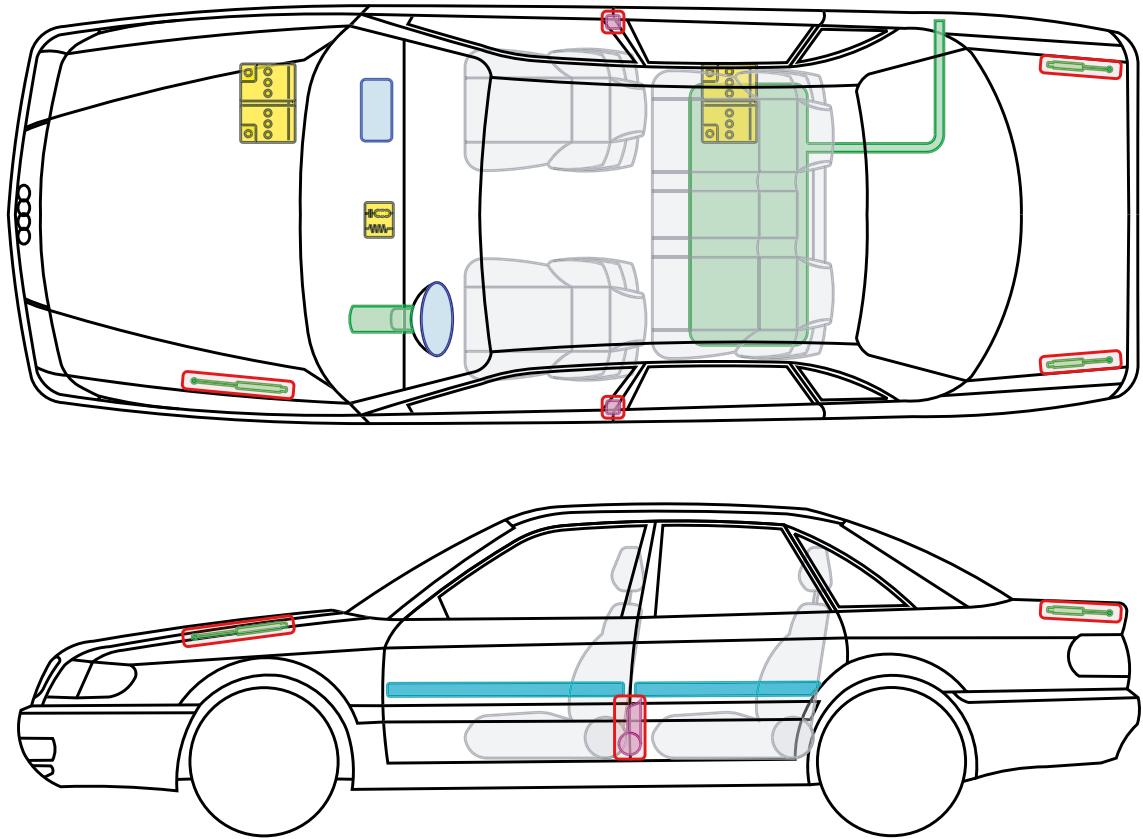

▶ Audi 100 / A6 / S6

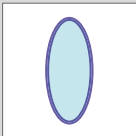
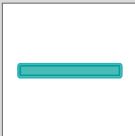
1991 – 1997

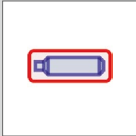

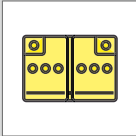
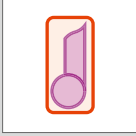
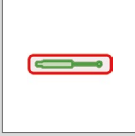
Legende

	Airbag		Karosserie- verstärkung		Steuergerät
	Gas- generator		Überroll- schutz		Batterie
	Gurt- straffer		Gasdruck- dämpfer		Kraftstoff- tank

Dieses Dokument unterliegt dem Copyright der AUDI AG, Ingolstadt. Jede Vervielfältigung, Verbreitung, Speicherung, Übermittlung, Sendung und Wieder- bzw. Weitergabe der Inhalte ist ohne schriftliche Genehmigung der AUDI AG ausdrücklich untersagt.







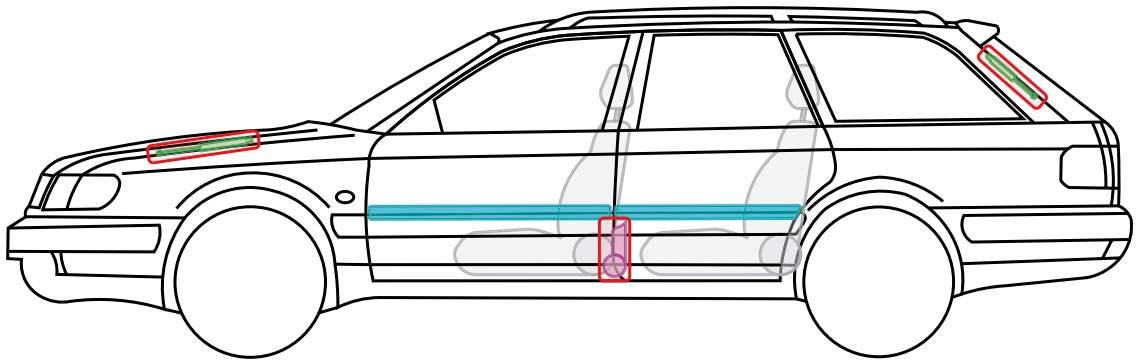
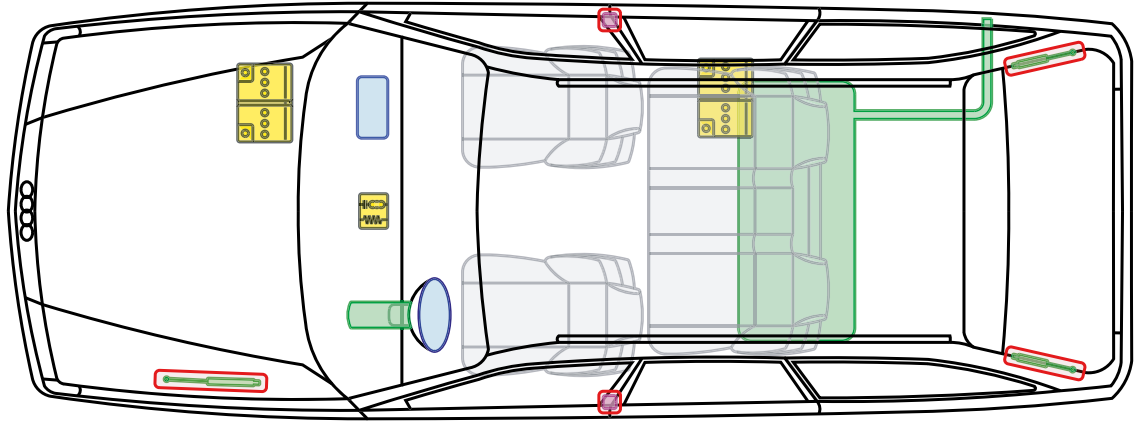

▶ Audi 100 / A6 / S6 Avant

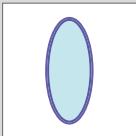
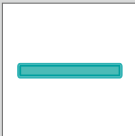
1991 – 1997

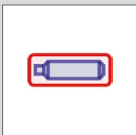

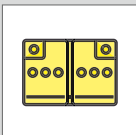
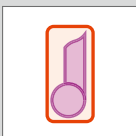
Legende

	Airbag		Karosserie- verstärkung		Steuergerät
	Gas- generator		Überroll- schutz		Batterie
	Gurt- straffer		Gasdruck- dämpfer		Kraftstoff- tank

Dieses Dokument unterliegt dem Copyright der AUDI AG, Ingolstadt. Jede Vervielfältigung, Verbreitung, Speicherung, Übermittlung, Sendung und Wieder- bzw. Weitergabe der Inhalte ist ohne schriftliche Genehmigung der AUDI AG ausdrücklich untersagt.



▶ Audi 200 / V8

1984 – 1991

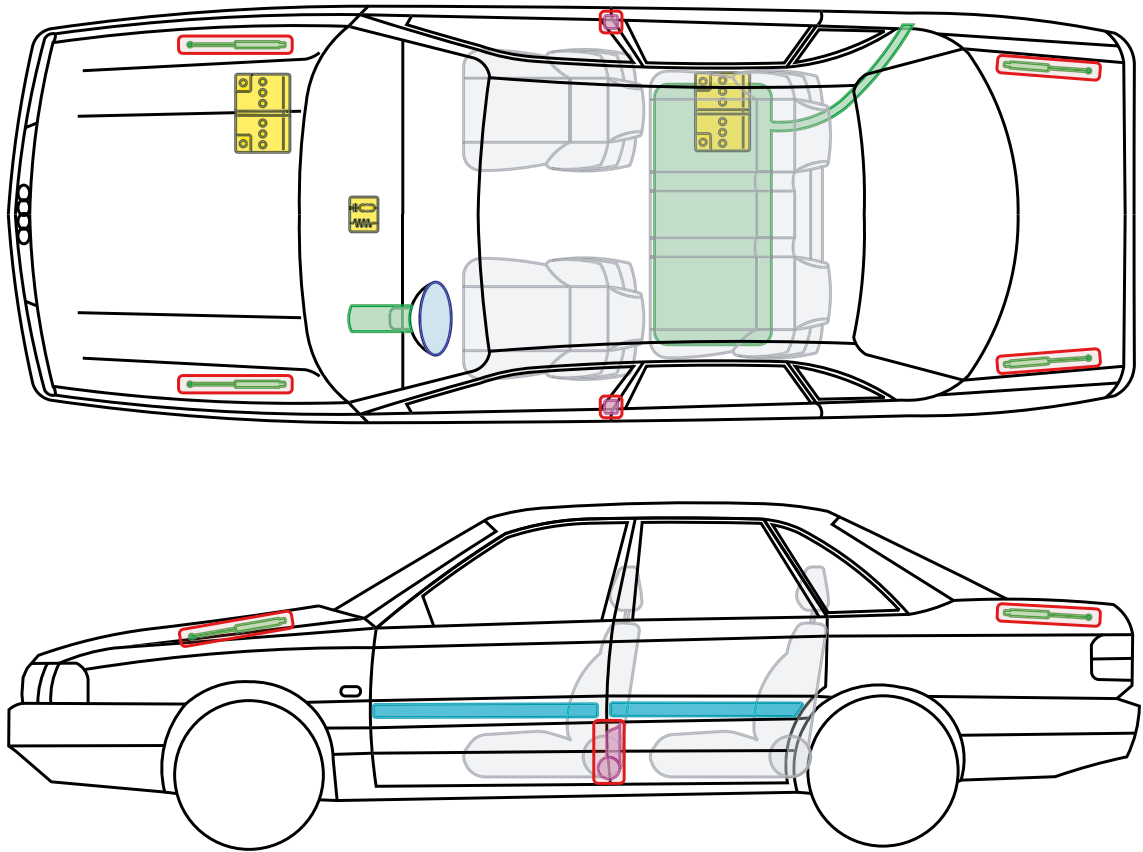

Legende

	Airbag		Karosserie- verstärkung		Steuergerät
	Gas- generator		Überroll- schutz		Batterie
	Gurt- straffer		Gasdruck- dämpfer		Kraftstoff- tank

Dieses Dokument unterliegt dem Copyright der AUDI AG, Ingolstadt. Jede Vervielfältigung, Verbreitung, Speicherung, Übermittlung, Sendung und Wieder- bzw. Weitergabe der Inhalte ist ohne schriftliche Genehmigung der AUDI AG ausdrücklich untersagt.







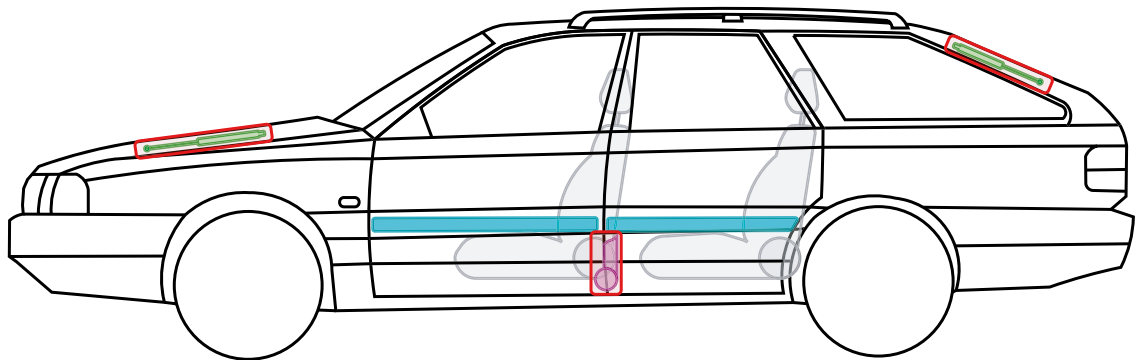
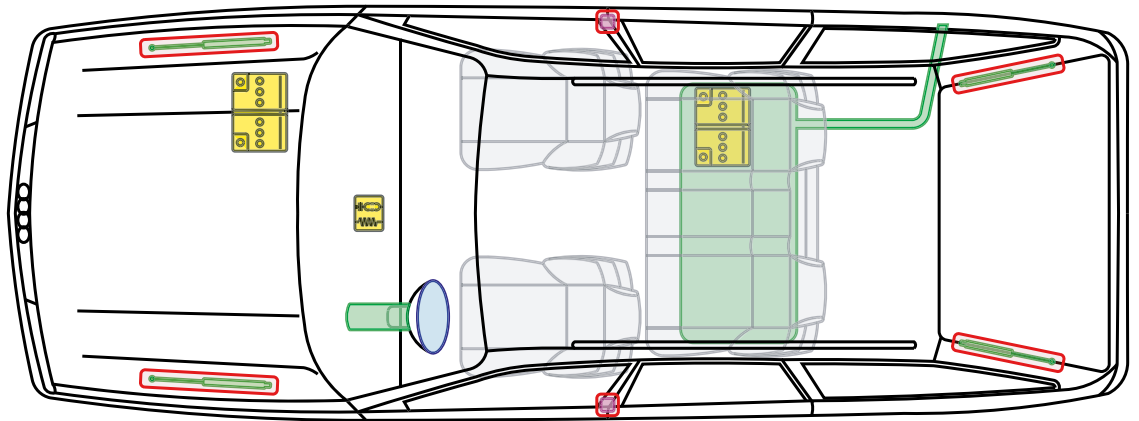

▶ Audi 200 Avant

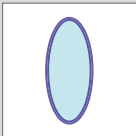
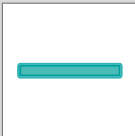
1985 – 1991

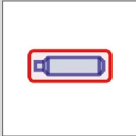

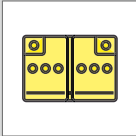
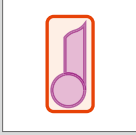
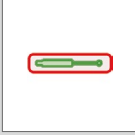
Legende

	Airbag		Karosserie- verstärkung		Steuergerät
	Gas- generator		Überroll- schutz		Batterie
	Gurt- straffer		Gasdruck- dämpfer		Kraftstoff- tank

Dieses Dokument unterliegt dem Copyright der AUDI AG, Ingolstadt. Jede Vervielfältigung, Verbreitung, Speicherung, Übermittlung, Sendung und Wieder- bzw. Weitergabe der Inhalte ist ohne schriftliche Genehmigung der AUDI AG ausdrücklich untersagt.





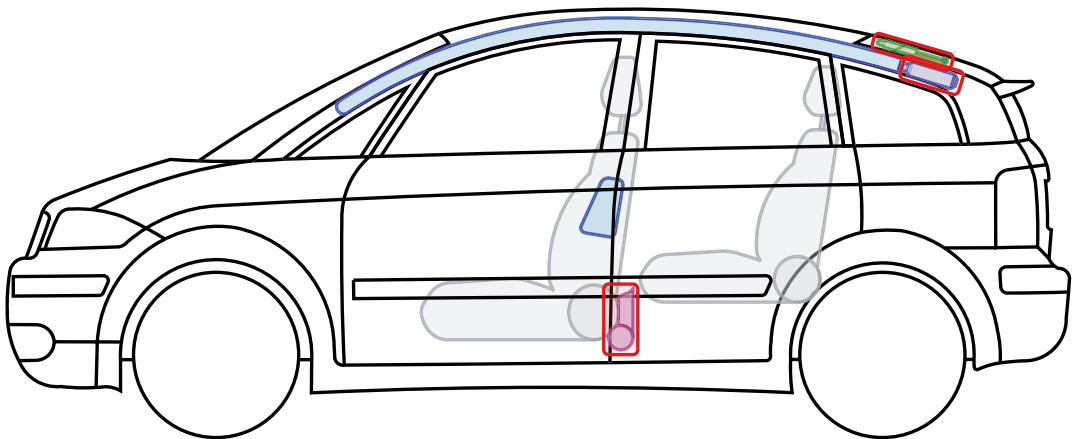
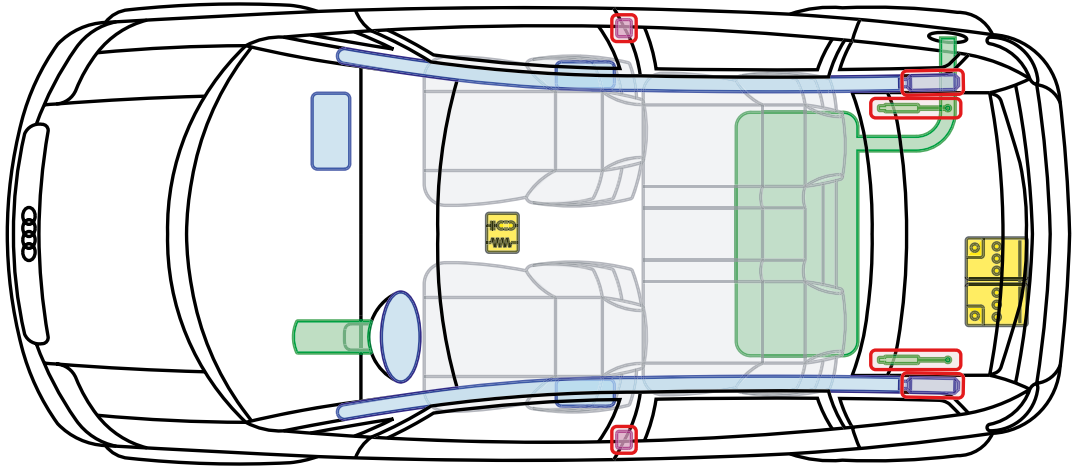

▶ Audi A2

2000 – 2005

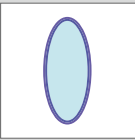
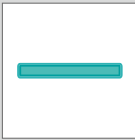

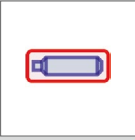
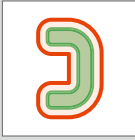
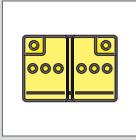
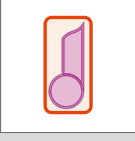
Legende

	Airbag		Karosserie- verstärkung		Steuergerät
	Gas- generator		Überroll- schutz		Batterie
	Gurt- straffer		Gasdruck- dämpfer		Kraftstoff- tank

A2
Limousine







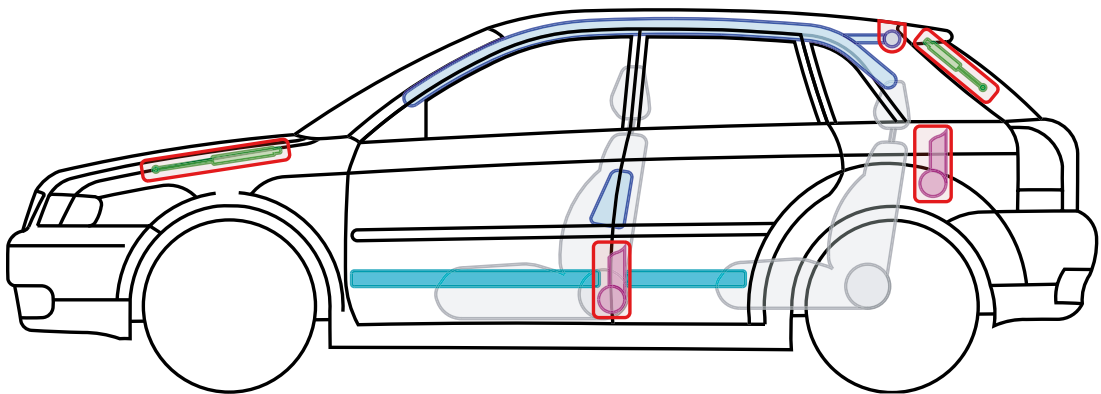
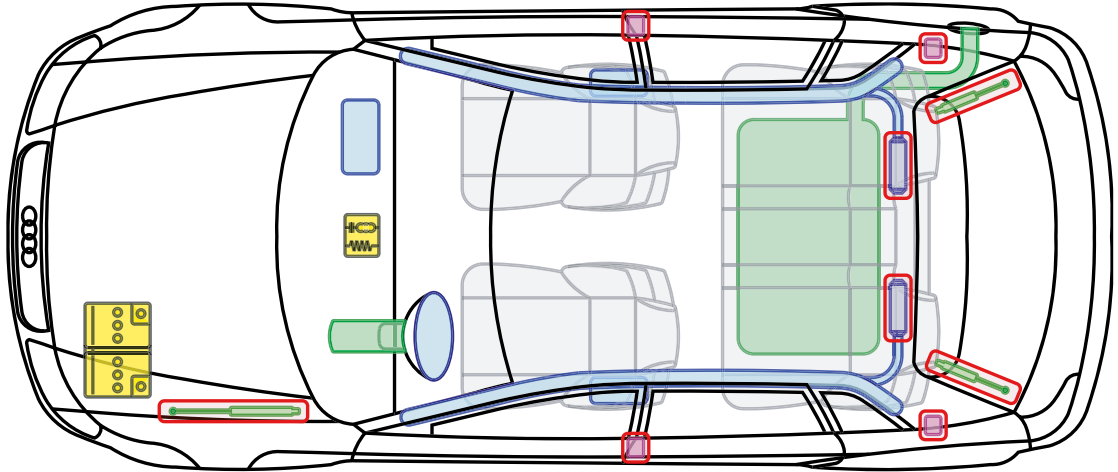

▶ Audi A3 (5-Türer)

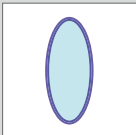
1999 – 2003

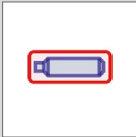

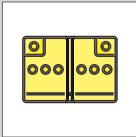
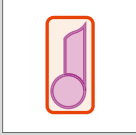
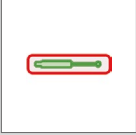
Legende

	Airbag		Karosserie- verstärkung		Steuergerät
	Gas- generator		Überroll- schutz		Batterie
	Gurt- straffer		Gasdruck- dämpfer		Kraftstoff- tank









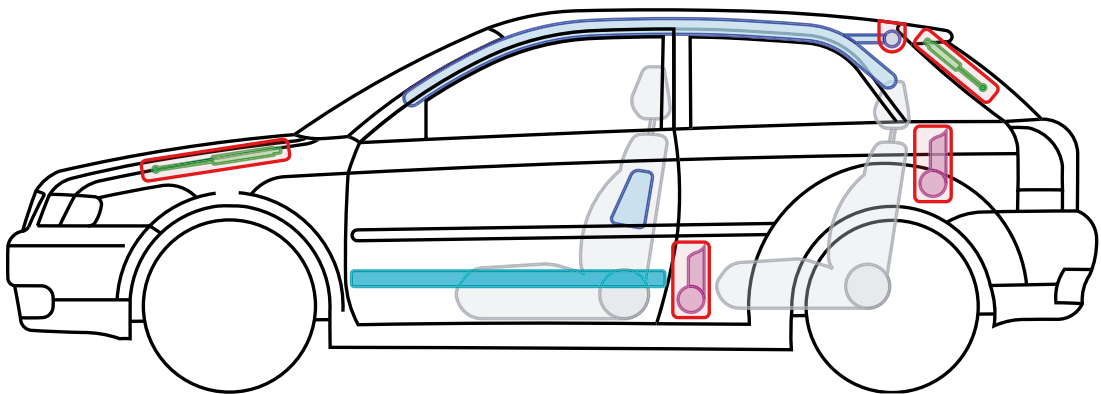
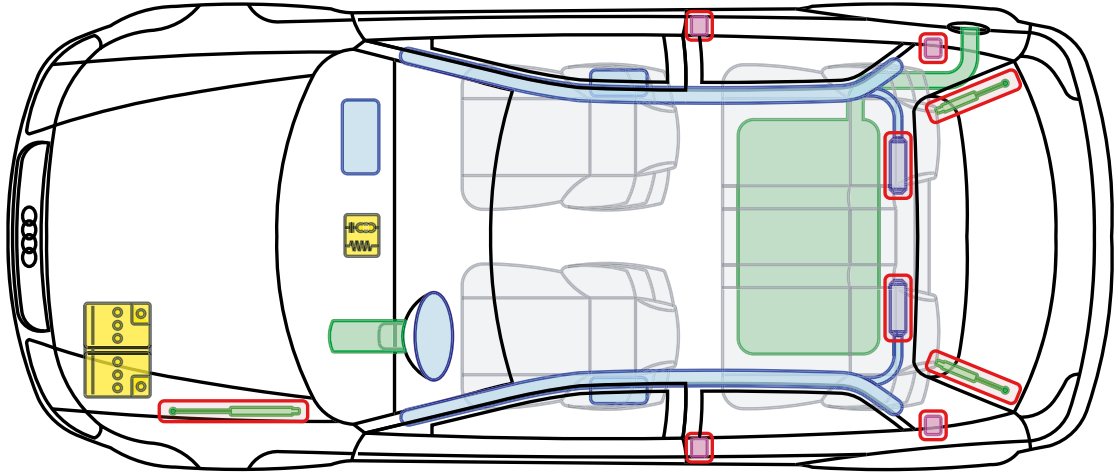

▶ Audi A3 / S3 (3-Türer)

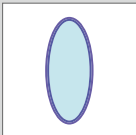
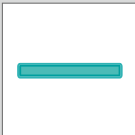
1996 – 2003

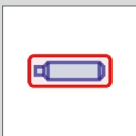

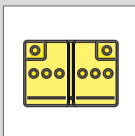
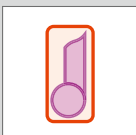
Legende

	Airbag		Karosserie- verstärkung		Steuergerät
	Gas- generator		Überroll- schutz		Batterie
	Gurt- straffer		Gasdruck- dämpfer		Kraftstoff- tank

A3 + S3 (3-Türer)









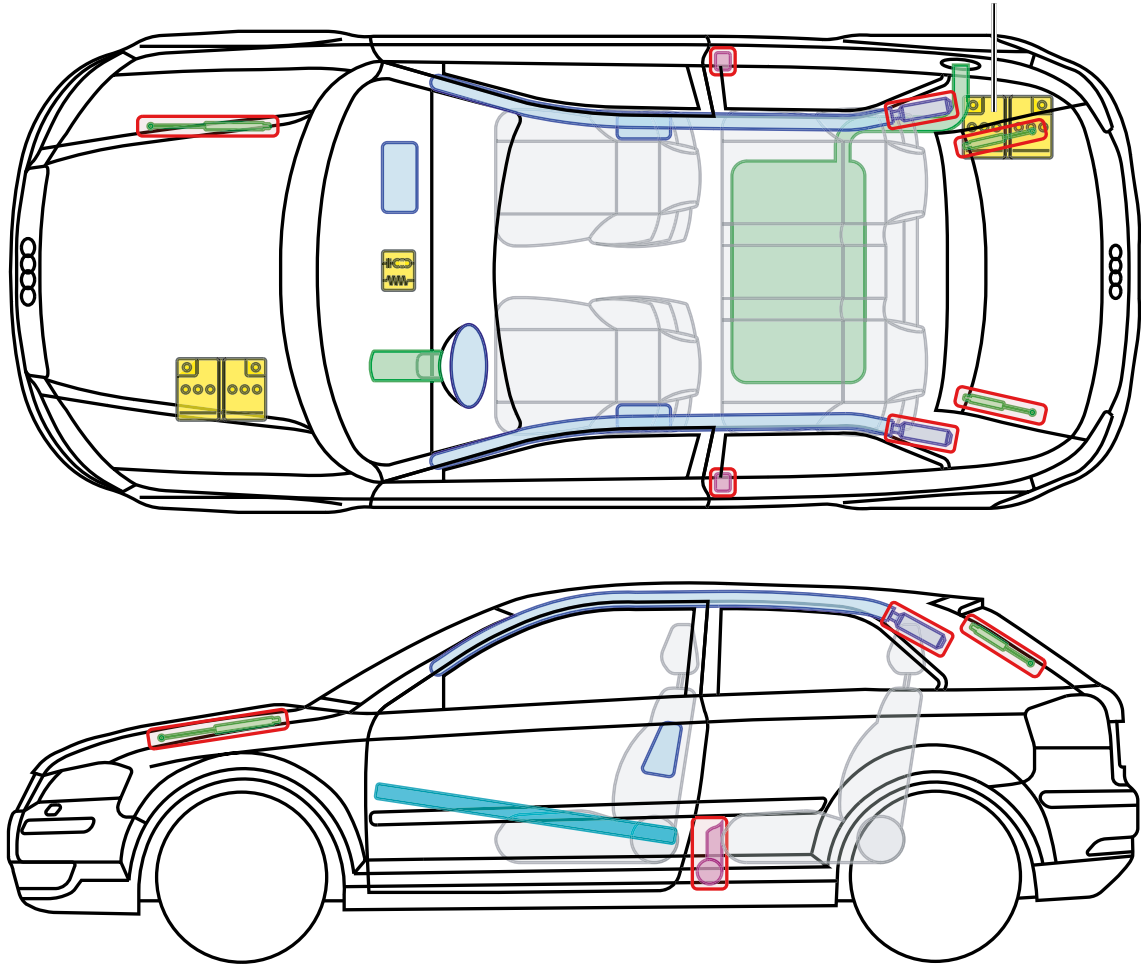

▶ Audi A3 / S3 (3-Türer)

2003 – 2012

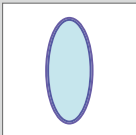
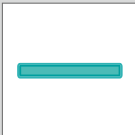
nur V6 quattro

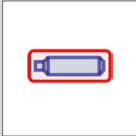

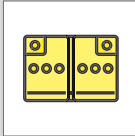
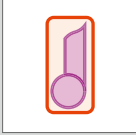
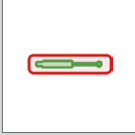
Legende

	Airbag		Karosserie- verstärkung		Steuergerät
	Gas- generator		Überroll- schutz		Batterie
	Gurt- straffer		Gasdruck- dämpfer		Kraftstoff- tank









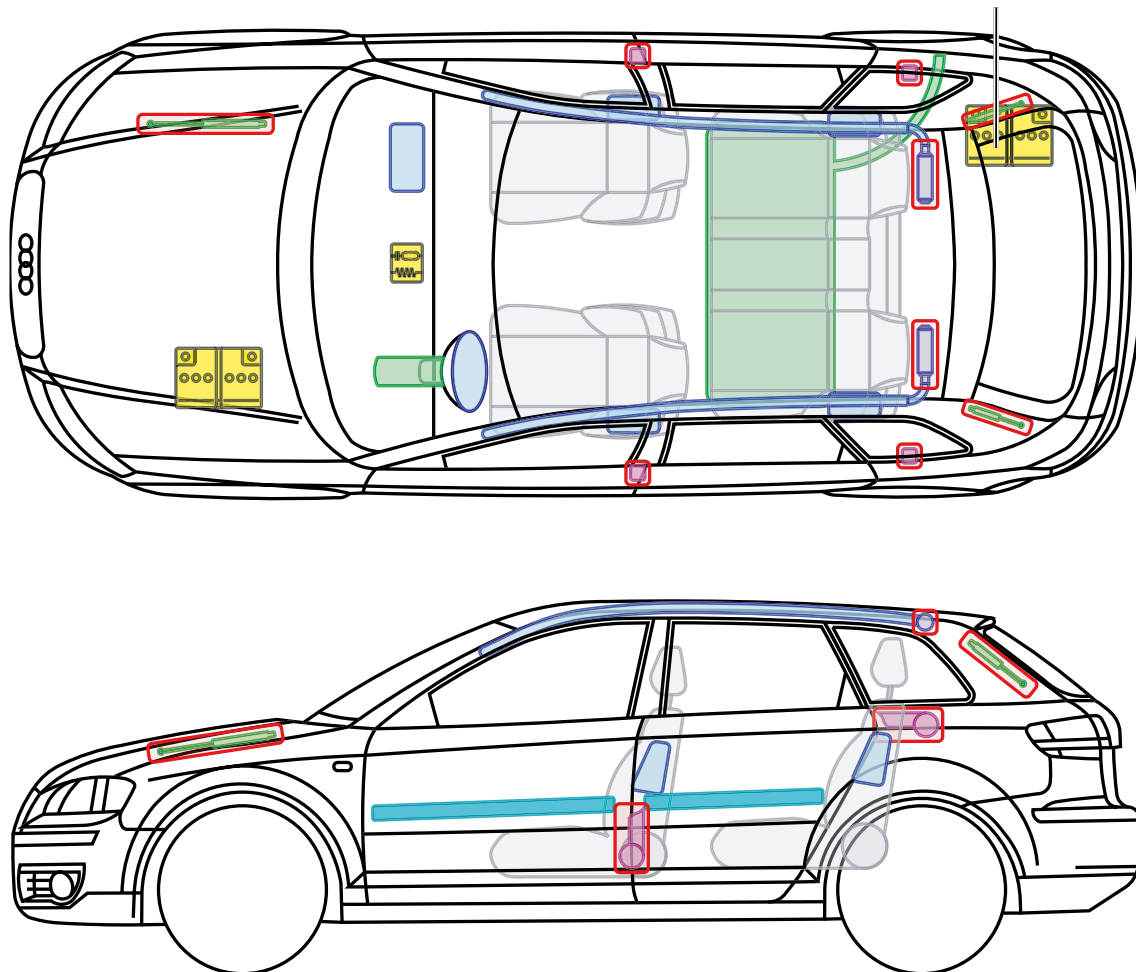

▶ Audi A3 / S3 /RS3 Sportback

2004 – 2013

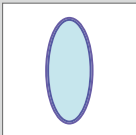
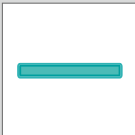
nur V6 quattro + RS3

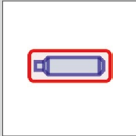

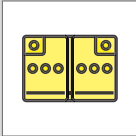
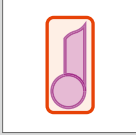
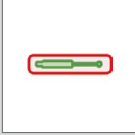
Legende

	Airbag		Karosserie- verstärkung		Steuergerät
	Gas- generator		Überroll- schutz		Batterie
	Gurt- straffer		Gasdruck- dämpfer		Kraftstoff- tank









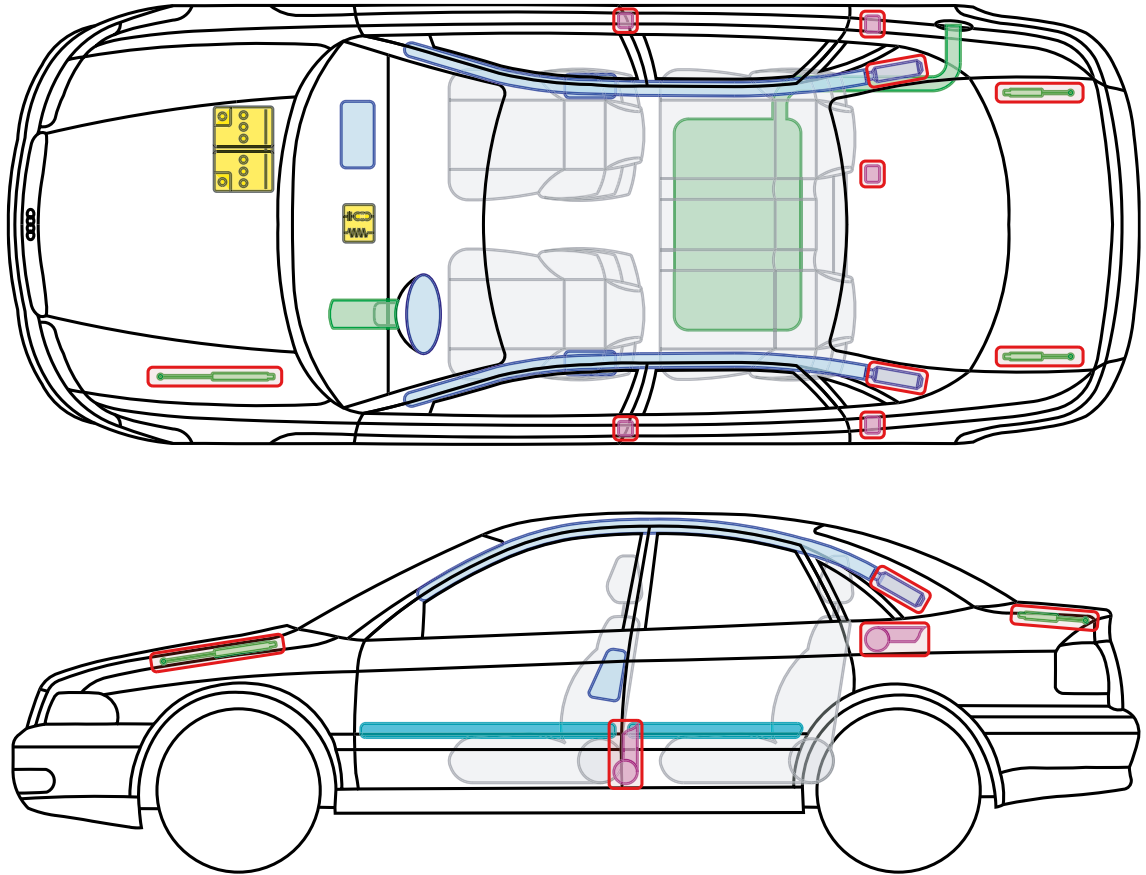

▶ Audi A4 / S4

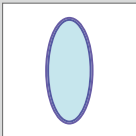
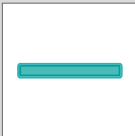
1995 – 2001

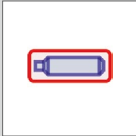

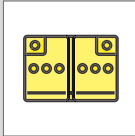
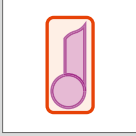
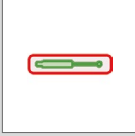
Legende

	Airbag		Karosserie- verstärkung		Steuergerät
	Gas- generator		Überroll- schutz		Batterie
	Gurt- straffer		Gasdruck- dämpfer		Kraftstoff- tank

A4 + S4 Limousine









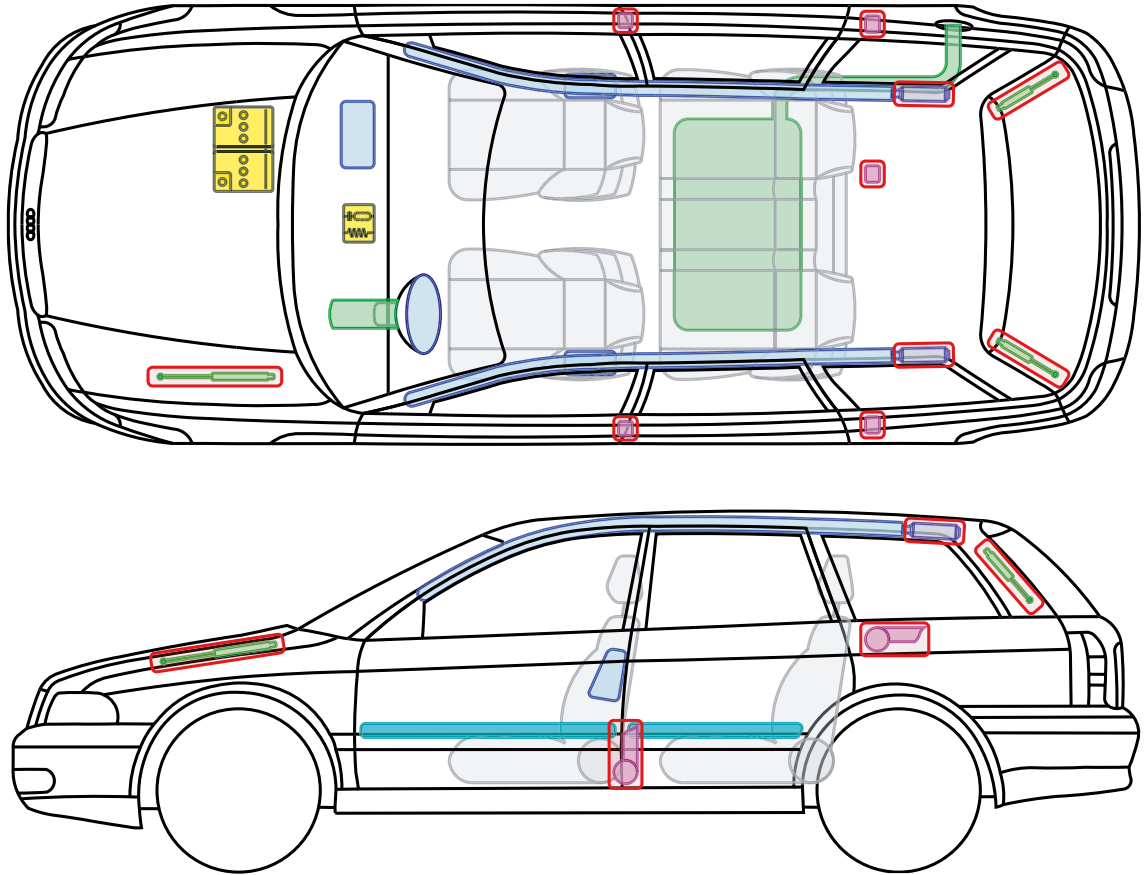

▶ Audi A4 / S4 / RS4 Avant

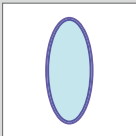
1996 – 2001

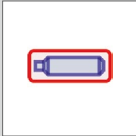

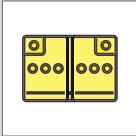
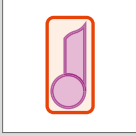
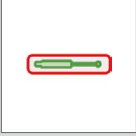
Legende

	Airbag		Karosserie- verstärkung		Steuergerät
	Gas- generator		Überroll- schutz		Batterie
	Gurt- straffer		Gasdruck- dämpfer		Kraftstoff- tank







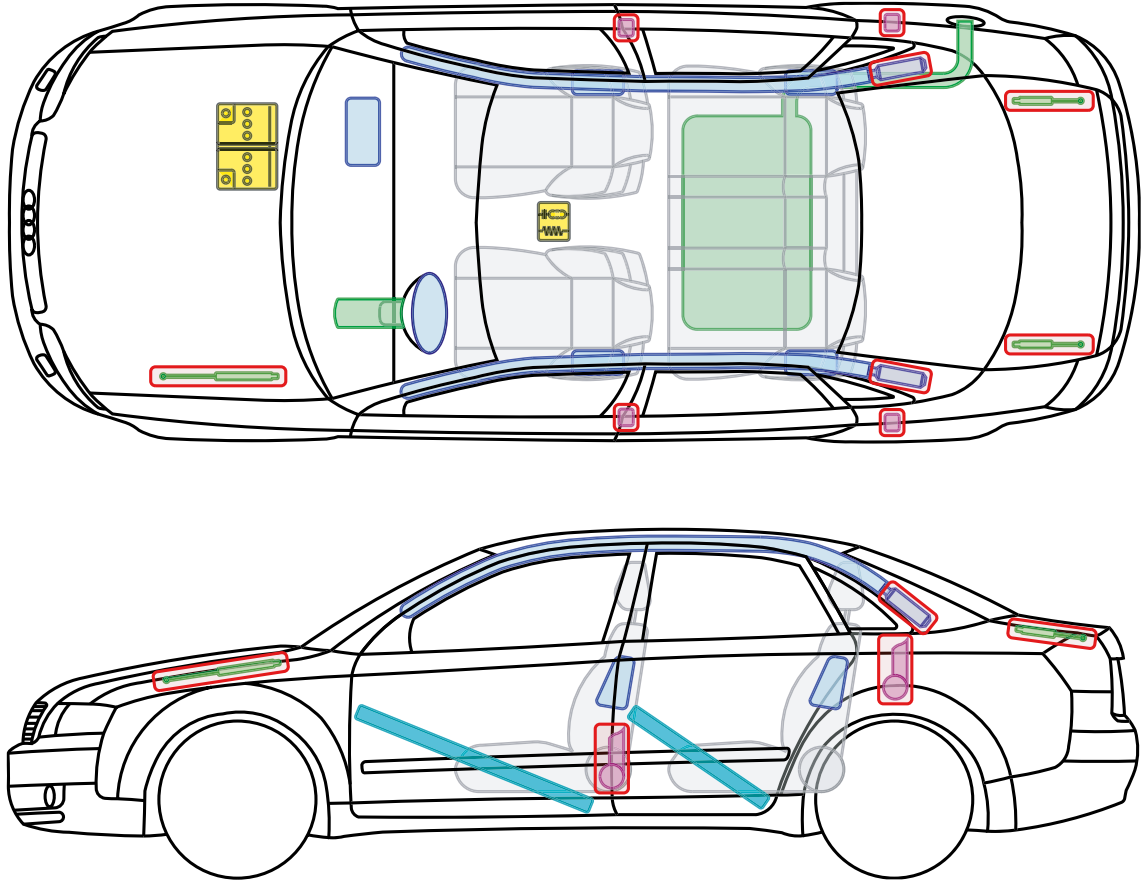

▶ Audi A4 / S4

2001 – 2005

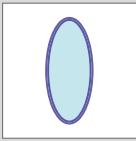
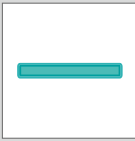

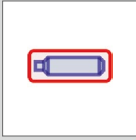
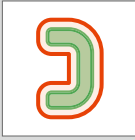
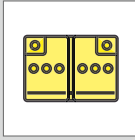
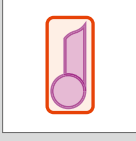
Legende

	Airbag		Karosserie- verstärkung		Steuergerät
	Gas- generator		Überroll- schutz		Batterie
	Gurt- straffer		Gasdruck- dämpfer		Kraftstoff- tank





▶ Audi A4 / S4 Avant

2001 – 2005

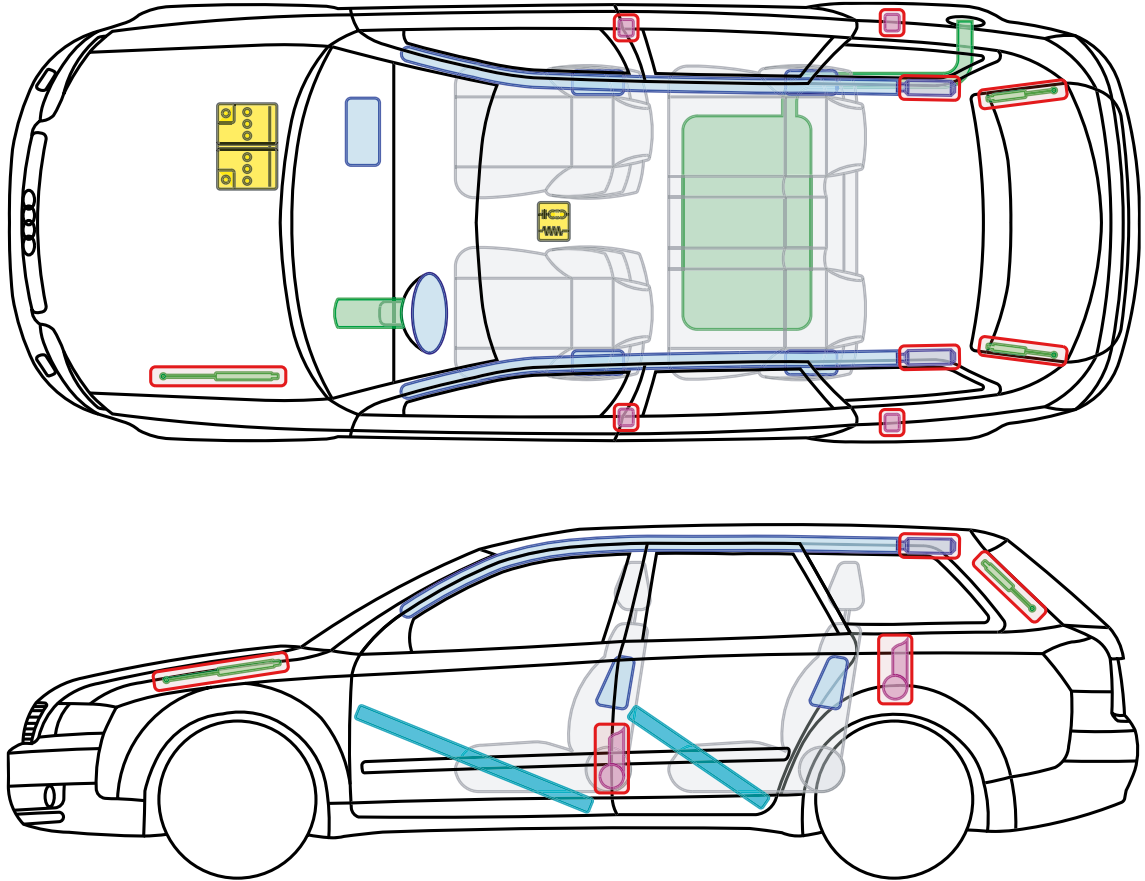

Legende

	Airbag		Karosserie- verstärkung		Steuergerät
	Gas- generator		Überroll- schutz		Batterie
	Gurt- straffer		Gasdruck- dämpfer		Kraftstoff- tank









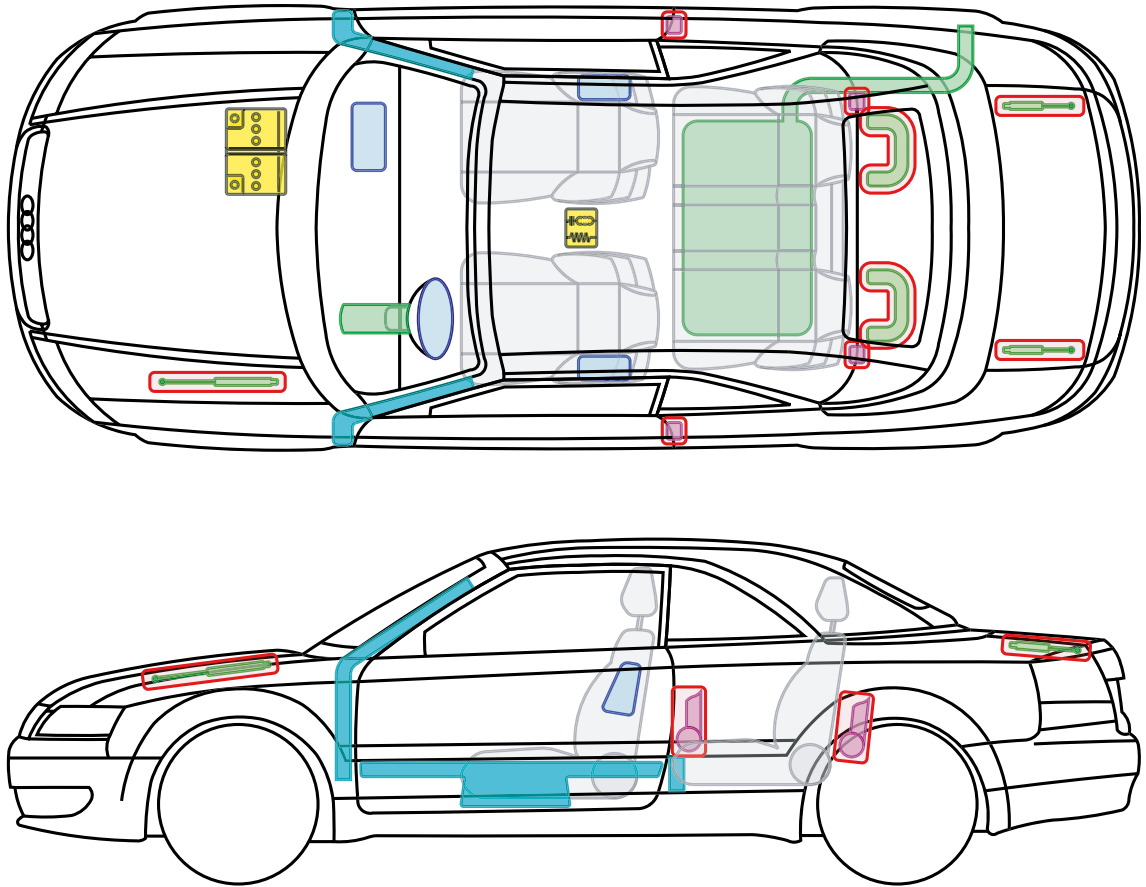

▶ Audi A4 / S4 Cabriolet

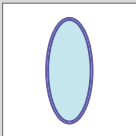
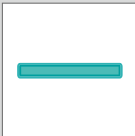
2002 – 2005

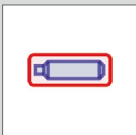

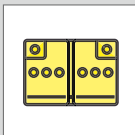
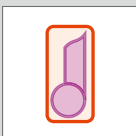
Legende

	Airbag		Karosserie- verstärkung		Steuergerät
	Gas- generator		Überroll- schutz		Batterie
	Gurt- straffer		Gasdruck- dämpfer		Kraftstoff- tank





▶ Audi A4 / S4 / RS4

2005 – 2007

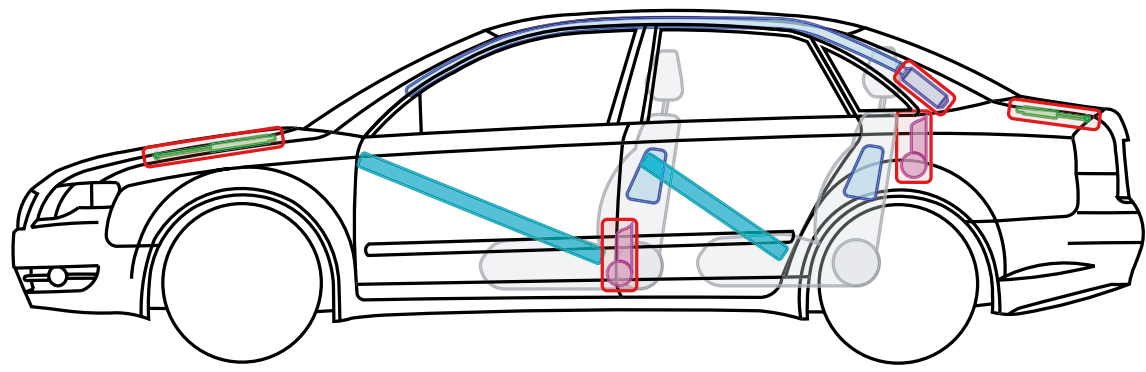

Legende

	Airbag		Karosserie-verstärkung		Steuergerät
	Gas-generator		Überroll-schutz		Batterie
	Gurt-straffer		Gasdruck-dämpfer		Kraftstoff-tank

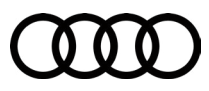



▶ Audi A4 / S4 RS4 Avant



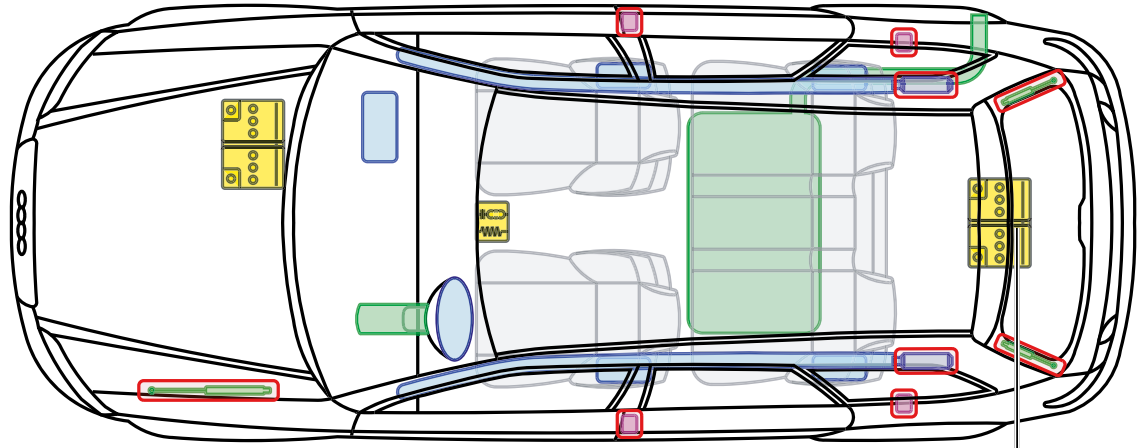

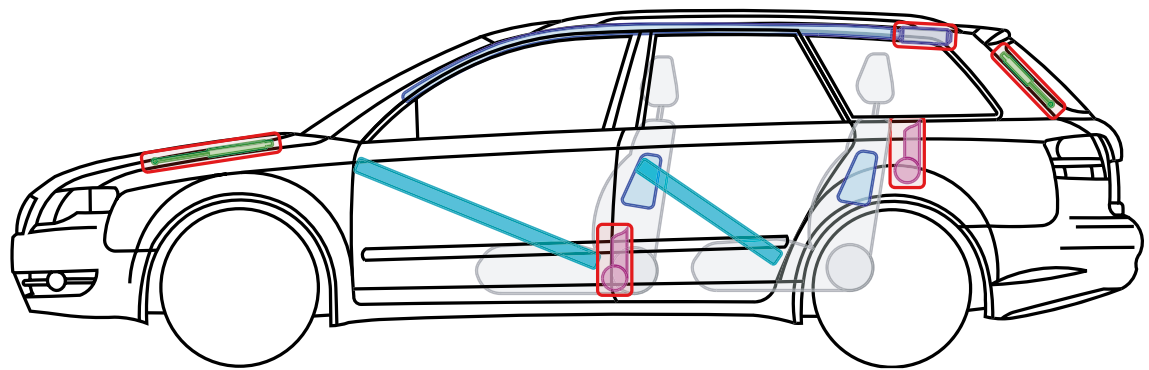

2005 – 2008

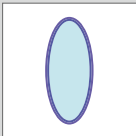
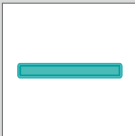

nur RS4

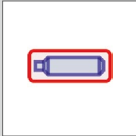

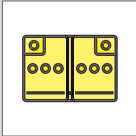
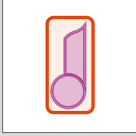
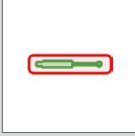
Legende

	Airbag		Karosserie- verstärkung		Steuergerät
	Gas- generator		Überroll- schutz		Batterie
	Gurt- straffer		Gasdruck- dämpfer		Kraftstoff- tank





▶ Audi A4 / S4 / RS4 Cabriolet



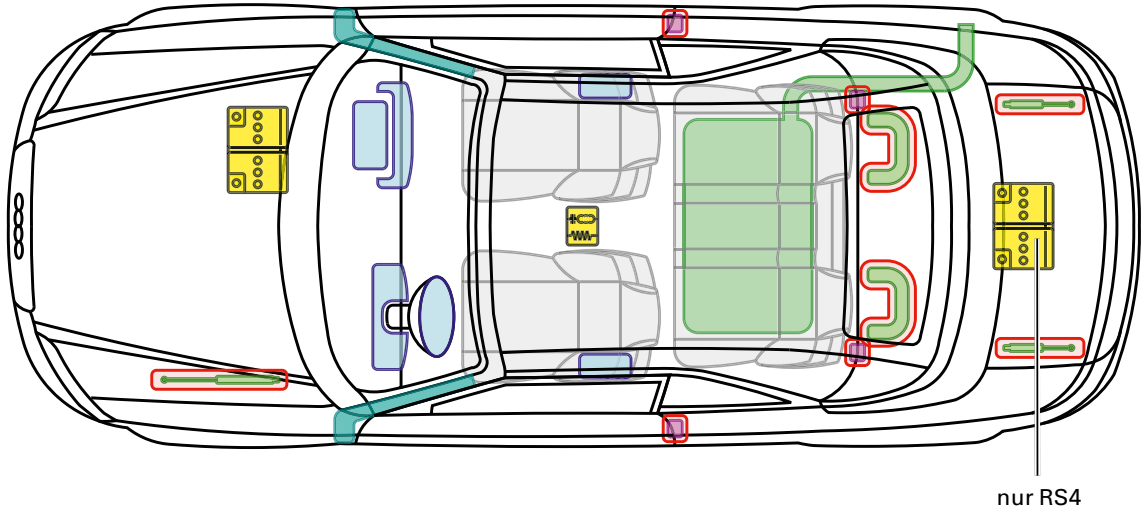

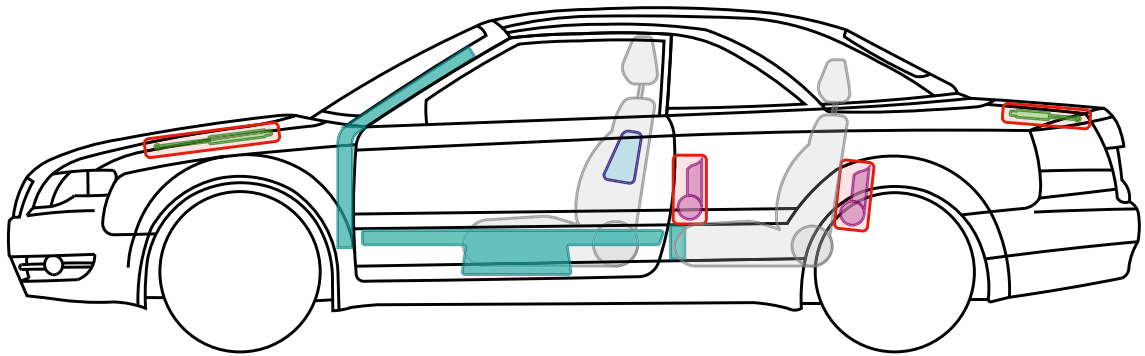

2005 – 2009

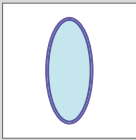
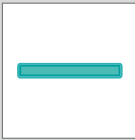

nur RS4

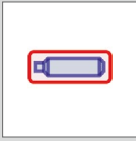

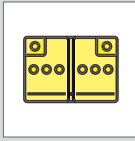
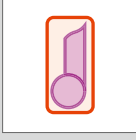
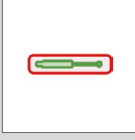
Legende

	Airbag		Karosserie- verstärkung		Steuergerät
	Gas- generator		Überroll- schutz		Batterie
	Gurt- straffer		Gasdruck- dämpfer		Kraftstoff- tank

A4 + S4/RS4 Cabriolet









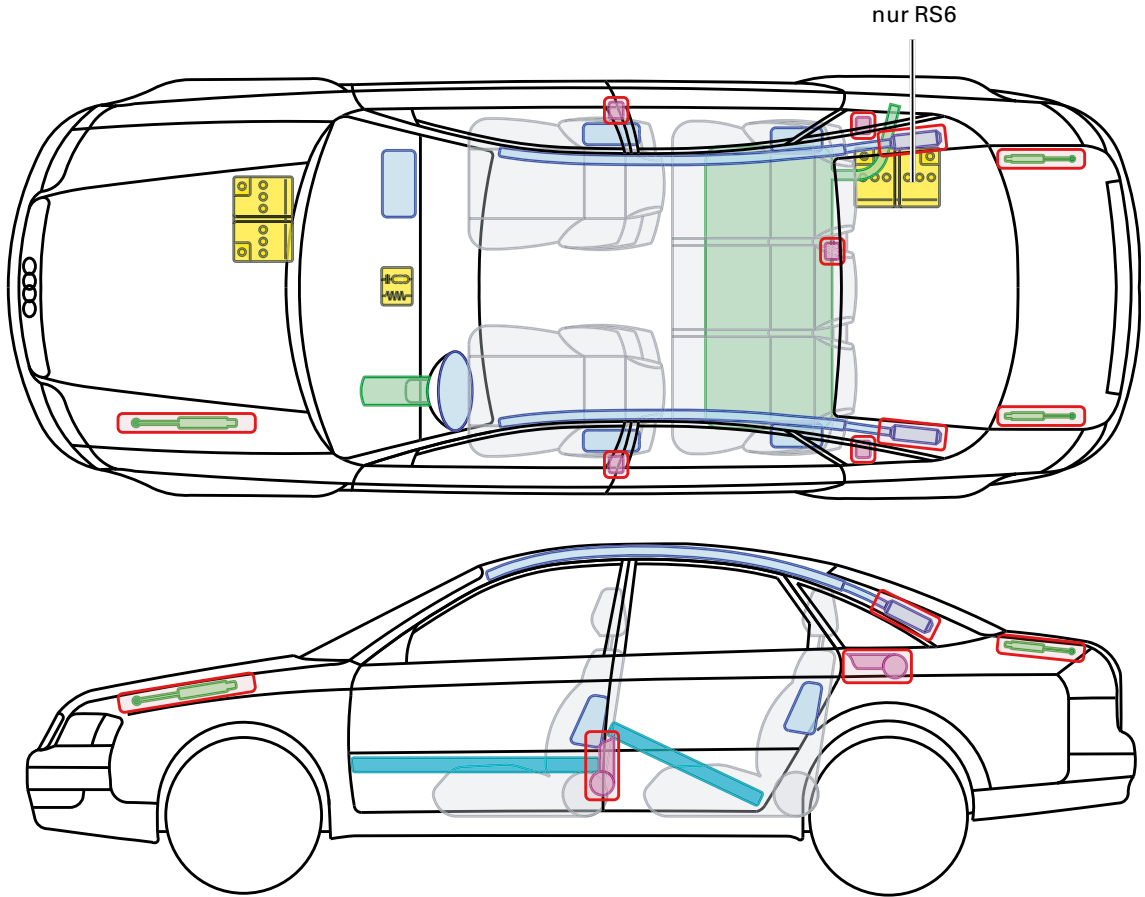

▶ Audi A6 / S6 / RS6

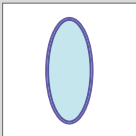
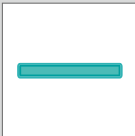
1997 – 2004

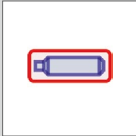

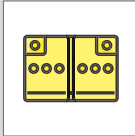
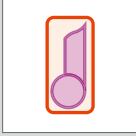
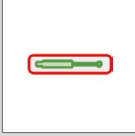
Legende

	Airbag		Karosserie- verstärkung		Steuergerät
	Gas- generator		Überroll- schutz		Batterie
	Gurt- straffer		Gasdruck- dämpfer		Kraftstoff- tank









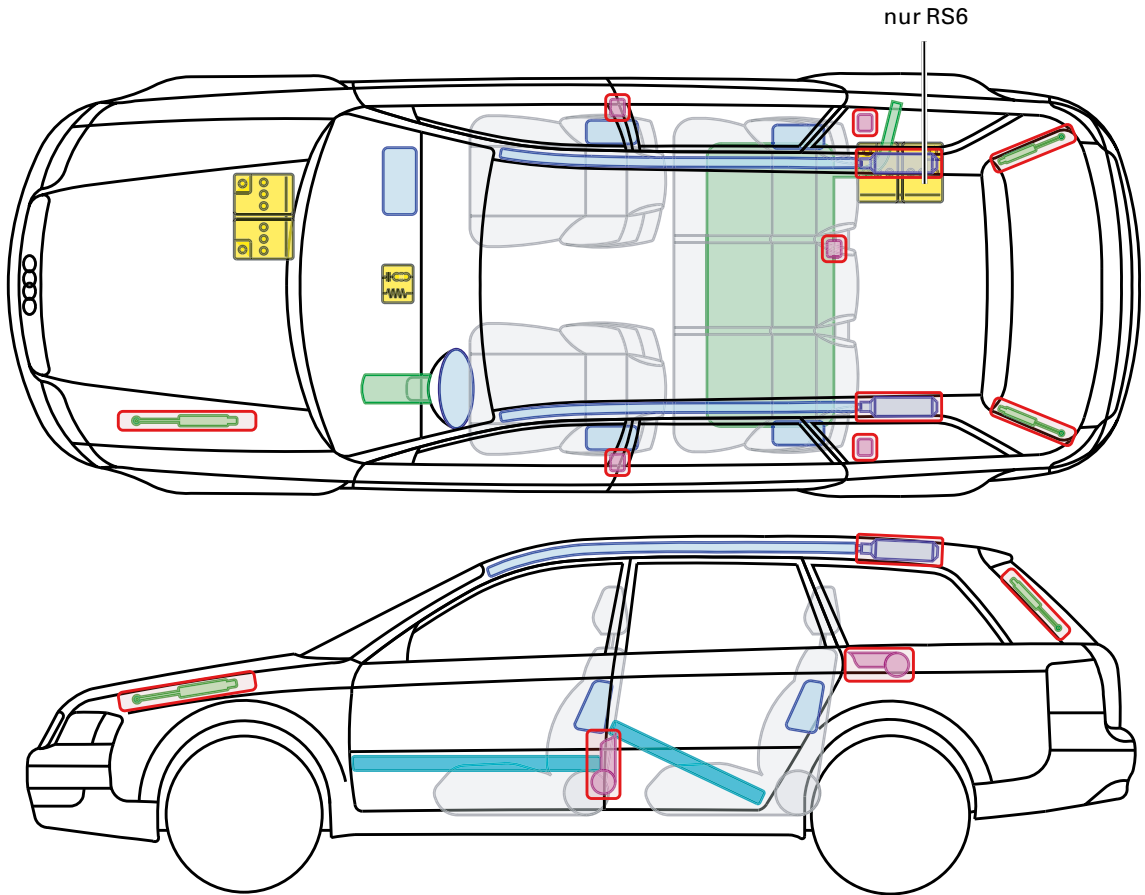

▶ Audi A6 / S6 / RS6 Avant

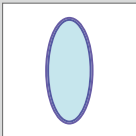
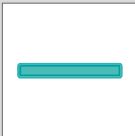
1998 – 2004

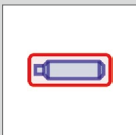

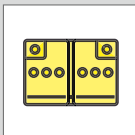
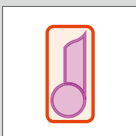
Legende

	Airbag		Karosserie- verstärkung		Steuergerät
	Gas- generator		Überroll- schutz		Batterie
	Gurt- straffer		Gasdruck- dämpfer		Kraftstoff- tank









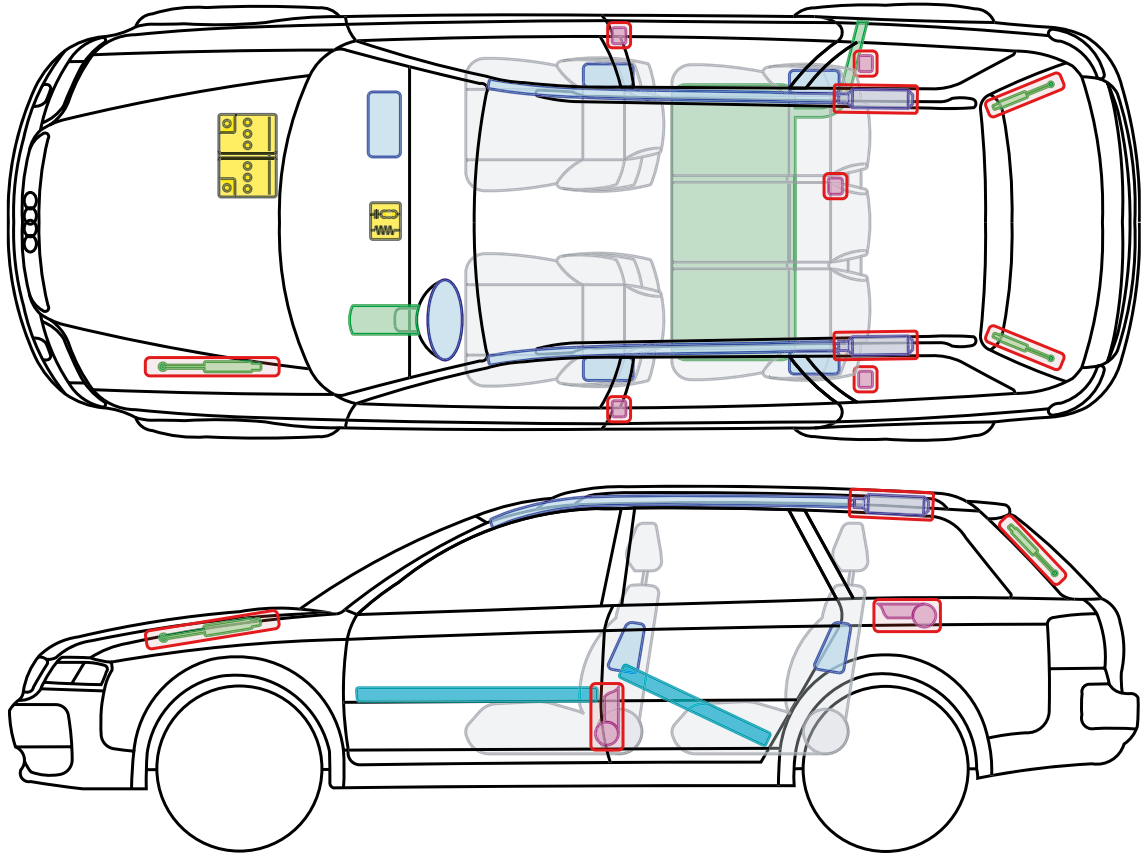

▶ Audi A6 allroad

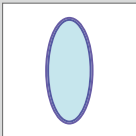
2001 – 2006

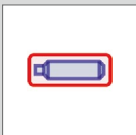

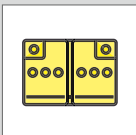
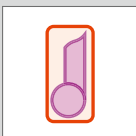
Legende

	Airbag		Karosserie- verstärkung		Steuergerät
	Gas- generator		Überroll- schutz		Batterie
	Gurt- straffer		Gasdruck- dämpfer		Kraftstoff- tank

A6 allroad







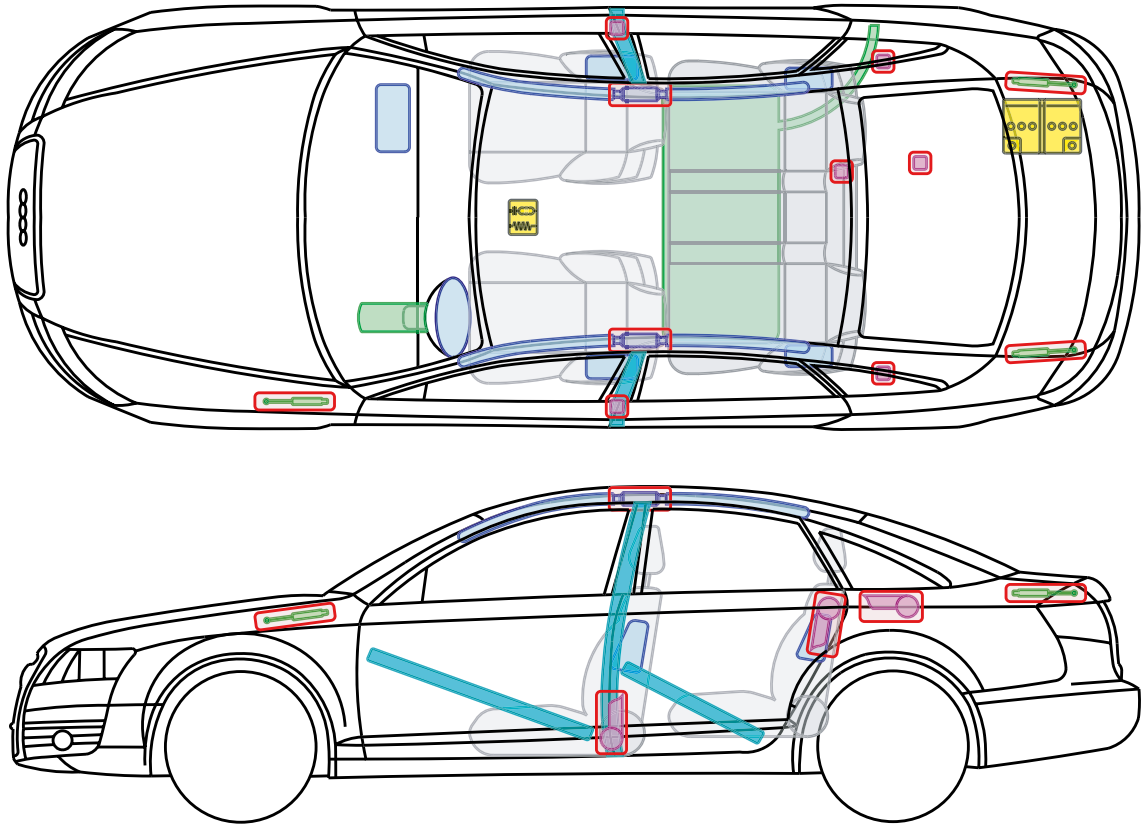

▶ Audi A6 / S6 / RS6

2004 – 2008

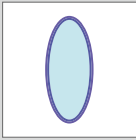
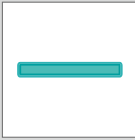

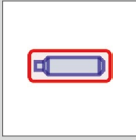
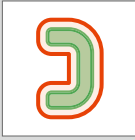
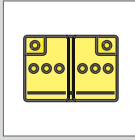
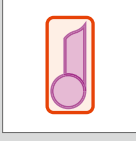
Legende

	Airbag		Karosserie- verstärkung		Steuergerät
	Gas- generator		Überroll- schutz		Batterie
	Gurt- straffer		Gasdruck- dämpfer		Kraftstoff- tank

A6 + S6/RS6 Limousine







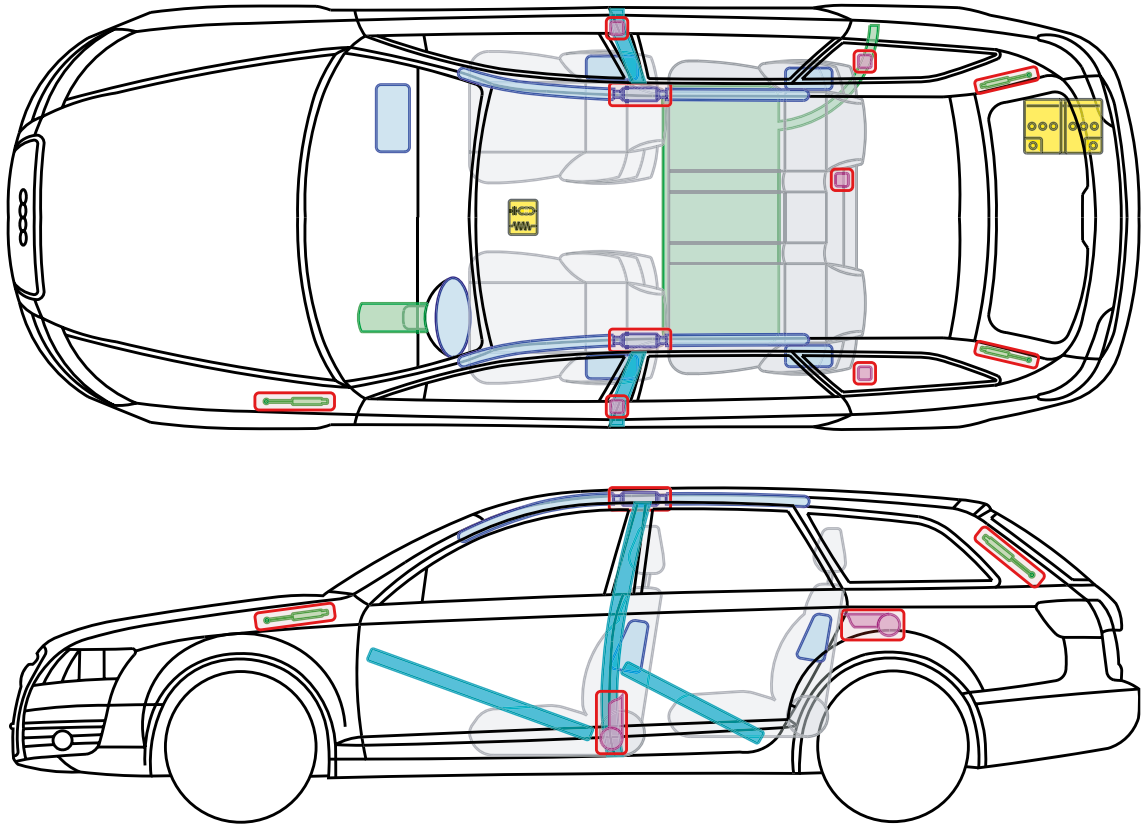

▶ Audi A6 / S6 / RS6 Avant

2004 – 2012

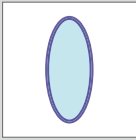
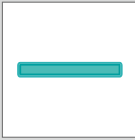

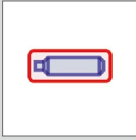
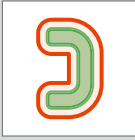
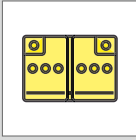
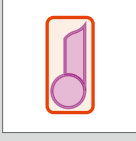
Legende

	Airbag		Karosserie- verstärkung		Steuergerät
	Gas- generator		Überroll- schutz		Batterie
	Gurt- straffer		Gasdruck- dämpfer		Kraftstoff- tank





▶ Audi A8 / S8

1994 – 2002

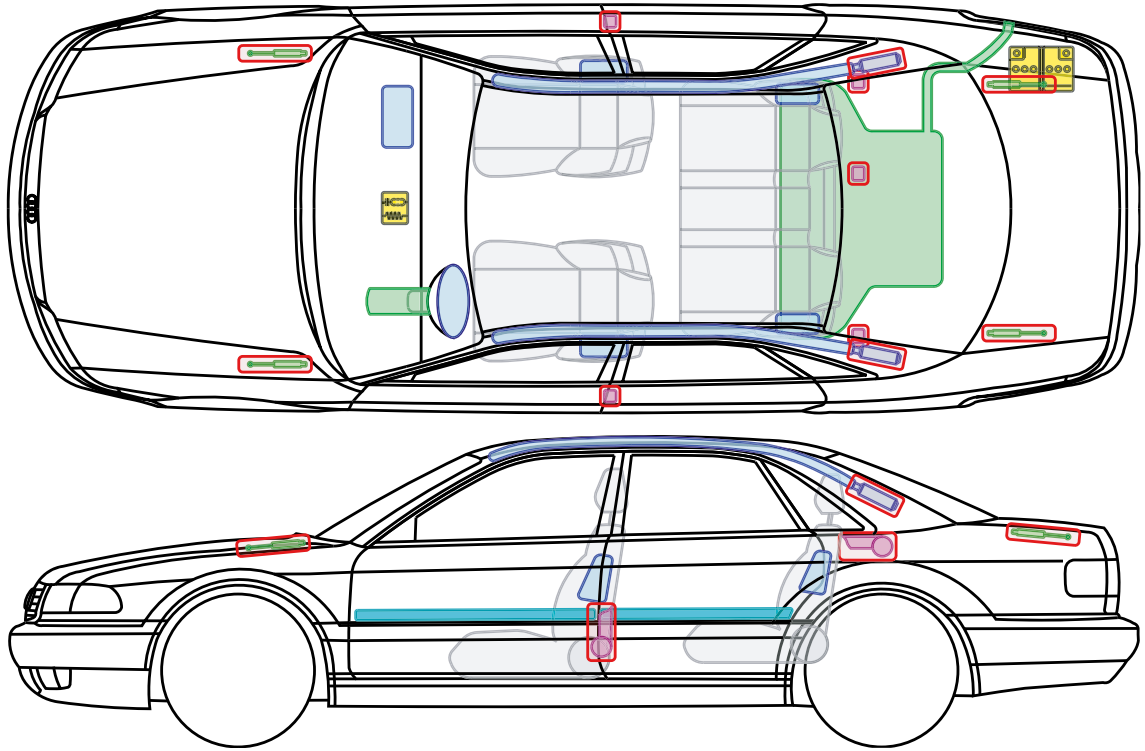

Legende

	Airbag		Karosserie- verstärkung		Steuergerät
	Gas- generator		Überroll- schutz		Batterie
	Gurt- straffer		Gasdruck- dämpfer		Kraftstoff- tank

A8 + S8 Limousine









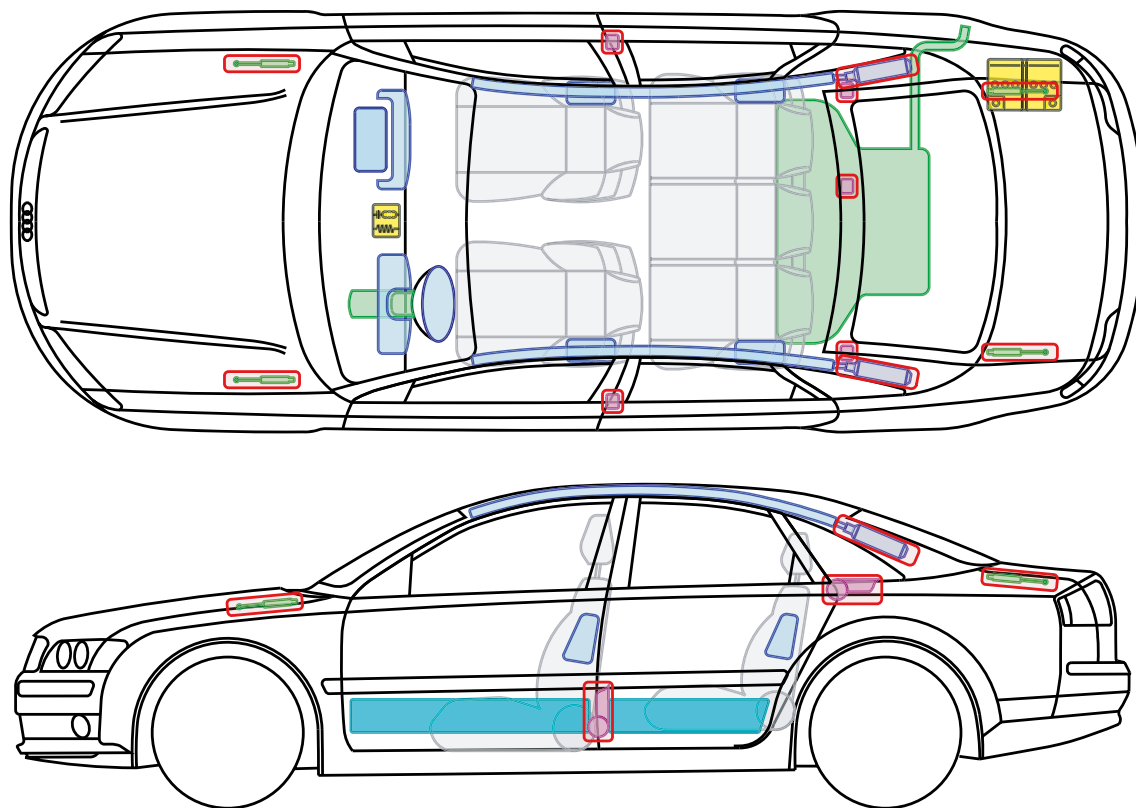

▶ Audi A8 / S8

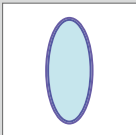
2002 – 2010

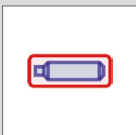

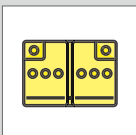
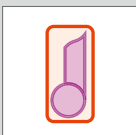
Legende

	Airbag		Karosserie- verstärkung		Steuergerät
	Gas- generator		Überroll- schutz		Batterie
	Gurt- straffer		Gasdruck- dämpfer		Kraftstoff- tank







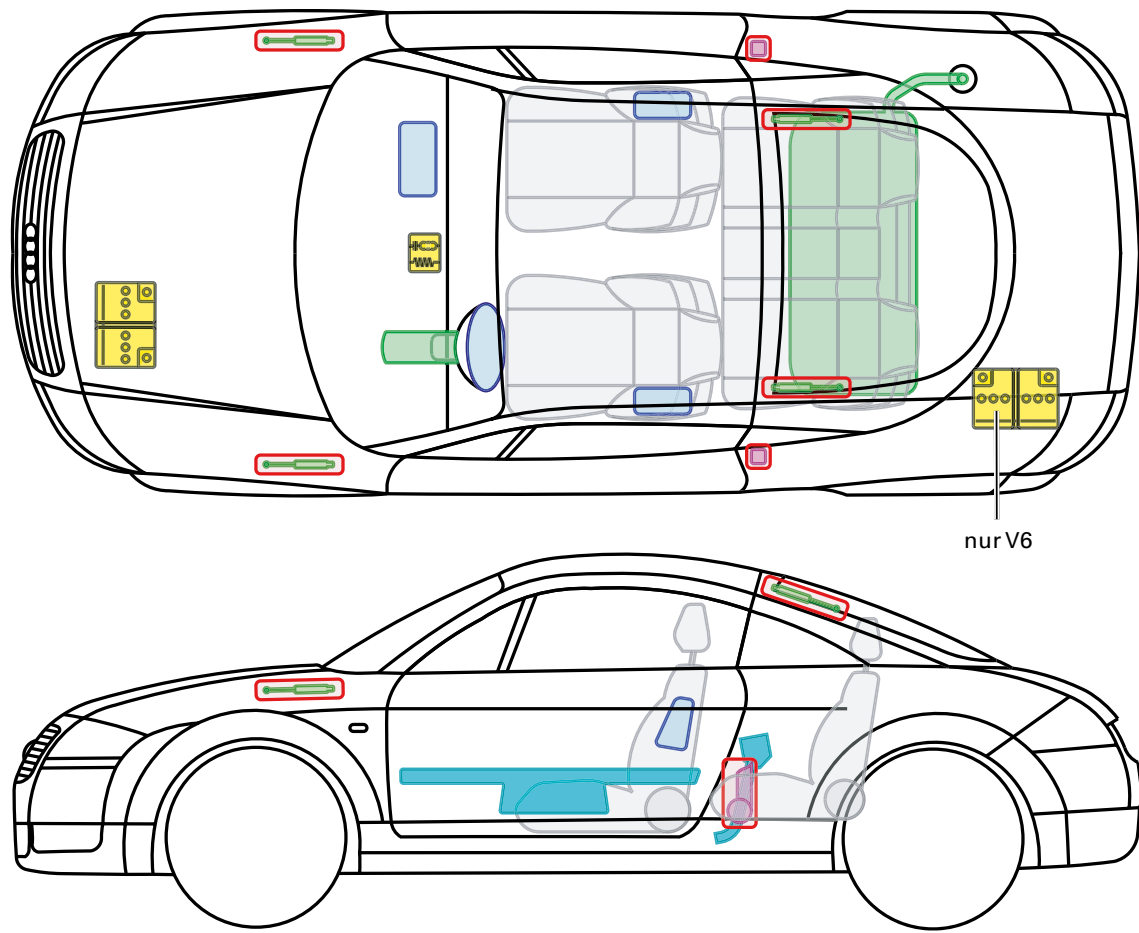

▶ Audi TT Coupé

1998 – 2006

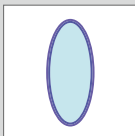
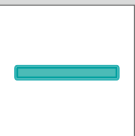
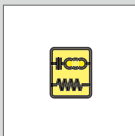
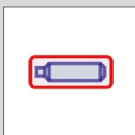

nur V6

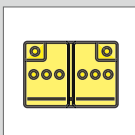
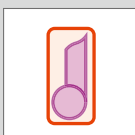
Legende

	Airbag		Karosserie- verstärkung		Steuergerät
	Gas- generator		Überroll- schutz		Batterie
	Gurt- straffer		Gasdruck- dämpfer		Kraftstoff- tank







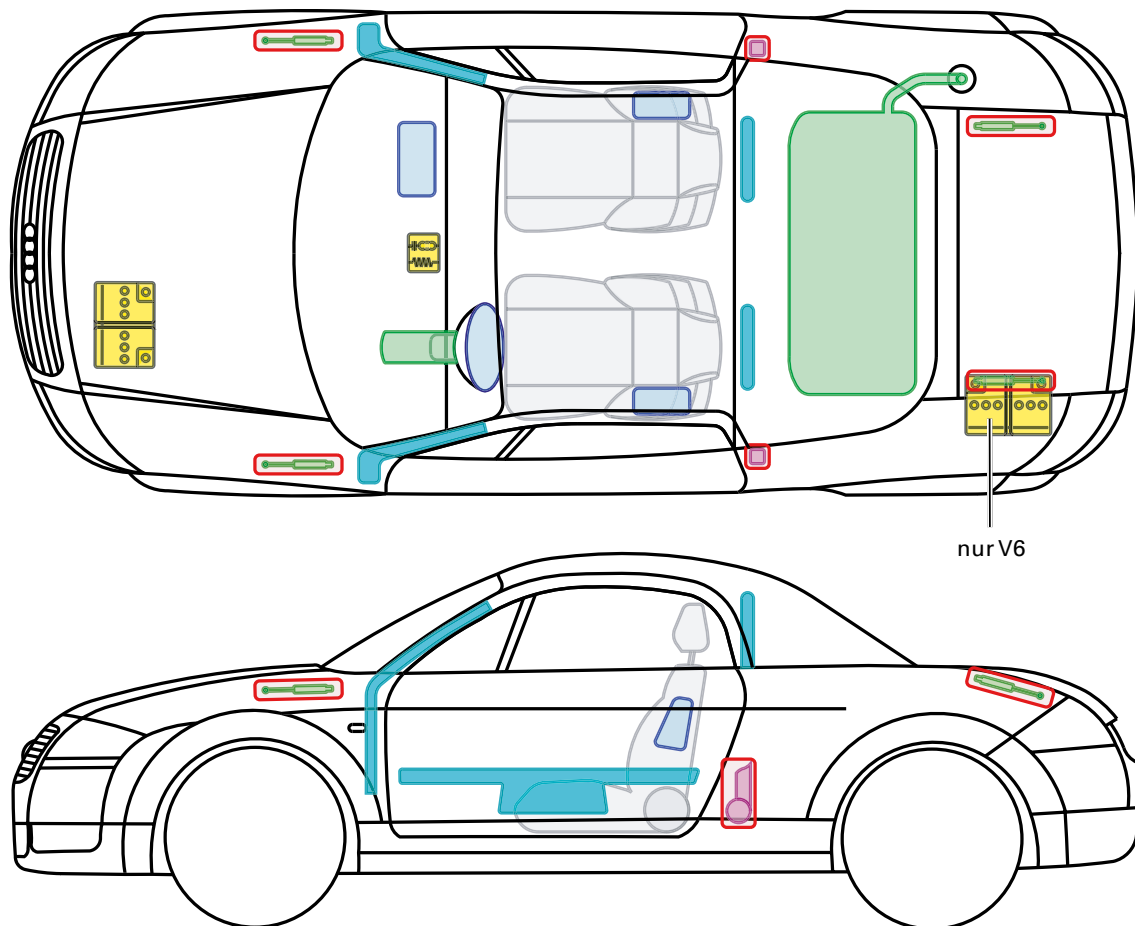

▶ Audi TT Roadster

1999 – 2006

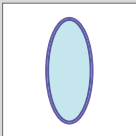

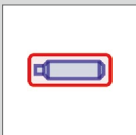
nur V6

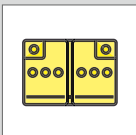
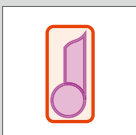
Legende

	Airbag		Karosserie- verstärkung		Steuergerät
	Gas- generator		Überroll- schutz		Batterie
	Gurt- straffer		Gasdruck- dämpfer		Kraftstoff- tank